



SAILUN RADIAL TRUCK TIRES CATALOGUE 2018

STEER / DRIVE / ALL POSITION / ON/OFF ROAD / WINTER / URBAN

WWW.GRUPOSAILUN.COM



Who Are We



World Renowned Manufacturer

From humble beginnings as a manufacturing testing platform to becoming the 18th largest manufacturer in the world in less than just over 10 years, Sailun pushes the limit of tire production research and development to ensure we stay customers centric. Our goal is always to provide customers and end users with the best value tire products and services. Therefore, we have established local distribution and sales support staff in key areas and ensured we partner with quality distributors who fall in line with the Sailun Tire vision.



Research & Development

The roots of Sailun dig deep and have close connections with one of the premiere schools focusing on rubber and tire technology – Qingdao School of Science and Technology. The cooperation between the school and Sailun continues to this day and together we are defining what it means to be a quality tire manufacturer. Sailun stays committed to this level of development by consistently investing 30% of our total revenue into our R&D programs.

Global Sales and Service Network ▼

We are dedicated to working with our partners closely. This is the driving force that pushed us to establish local workforces in key markets who provide localized services, products, and support. This strong relationship ensures that customers are receiving the best quality-value products possible.

Our Passion

Our passion is our customers - we push our own capabilities every day to ensure you receive the best quality products and services to boost your business.

Our Vision

We look to create a product for end-users worldwide that provide comparable quality and safety, but at a value price.



History

2002

On November, Qingdao Sailun Tire Co., LTD. was established.

2003

In April, the Sailun Industrial Park was completed.



The first Sailun tire comes off the line in December. From the beginning of construction to the first tire product, it took only 231 days to complete. An industry record.

2004

In September, the company obtained the DOT product certification from the transportation authority in the United States of America.



2006

In November, the first all steel OTR tire product was successfully produced.

2007

July, PCR tire factory is put into use.

Company is renamed to "Sailun Tire Co., LTD."

2008

In August, the company began renovations on the tire demonstration production line. This major technical project started with the support of the National Development and Reform Commission of China.



2009

In April, the company was awarded the honor of being named the tire technology research demonstration base of China.

September, the first Giant OTR tire finishes production.



2011

Sailun becomes the first private tire manufacturer to be listed on the Shanghai Stock Exchange.



2012

April, Sailun Vietnam factory starts construction.

In June, the research and development center was put into use.



Sailun obtains majority stake in Shenyang Peace Dove Tire Co., LTD.

2013

In June, the Sailun Vietnam factory was successfully put into production, and the new OTR product size of 40.00R57 was approved.

SAILUN + JINYU

2014

In January, the company acquired a 100% stake in KRT Group.



In April, Sailun acquired a 52% stake in Goma Group.

Jinyu Industrial and Sailun Tire merged to form "Sailun Jinyu Group Co., LTD".

2015

July, Sailun Jinyu Group and Zhengzhou Nissan enter their first race together at the Taklimakan International Rally.



2016

In August, the world's largest sized OTR tire (63-inches) successfully rolls off the line.

SAILUN-PTPA FOUNDATION



Sailun Tire was tested in North America by parents from the Parent Tested Parent Approved (PTPA) foundation and has numerous products approved for safety on the road. Check out our list of approved products here:

<http://ptpa.com/winners/>

SAILUN-WCC PARTNERSHIP

Sailun Tire is proud to announce their new partnership with the World Child Cancer Charity (WCC), an organization dedicated to the treatment of children with cancer in developing countries.

The inequality of diagnosing and treating children diagnosed with cancer between high and middle/low income countries is astounding. 200,000 children develop cancer worldwide each year with 80% of those children being located in low or middle income countries with only a 5% survival rate, compared to the 80% in high income countries. These low survival rates are attributed to shortage of specifically trained doctors and nurses, poor diagnosis and mistaken belief that child cancer is too difficult to cure. The work that WCC does is to treat children with cancer in the areas where treatments are not easily available or affordable.



WCC's mission is to bring greater awareness to cancer, cancer diagnosis, treatment and palliative care. Their vision is to raise survival rates to between 50-60% by treating children with relatively simple protocols and inexpensive drugs. Projects such as Malawi, started in 2009, are already seeing such progress. They fund international twinning partnerships which link experienced pediatric oncologists, nurses and healthcare workers from world renowned child cancer units in developed countries to projects in South America, Cameroon, Malawi, Ghana, Bangladesh, Philippines and Myanmar.

In 2014 alone, WCC trained 850 healthcare workers, funded nine projects in 16 different countries and set up a new project, Wilms' Tumour Collaboration across six African countries. They also opened a new project in Myanmar after a successful partnership with the Financial Times and received their first government funding projects in Ghana and Bangladesh.

"We are small but ambitious and, with Sailun's help, we will be able to achieve our plans for 2015 and beyond. These plans include extending our project in the Philippines by creating more satellite centers; expanding our newest project in Myanmar; and continuing to work with the Department of International Development to invest further in our Ghana and Bangladesh projects.

We are extremely grateful for this support from Sailun and its network, and look forward to working with you this year to improve the chances of survival for children with cancer in the developing world."



<http://www.worldchildcancer.org>

STEER / TRAILER

S605 P10
S606 P11
S607 P12
S622 P13
S626 P14
S628 P15
S629 P16
SFR1 P17
SRT1 P18
S636 P19
S637 P20
S637+ P21
S665 P22
S668 P23
S698 P24
S696 P25

DRIVE

S701 P26
S705 P27
S702 P28
S711 P30
S712 P31
S737 P32
S740 P33
S753 P34
S757 P35
S758 P36
S767 P37
S768 P38
S792 P39

ALL POSITION

S811 P40
S812 P41
S815 P42
S816 P43
S825 P44
S826 P45
S827 P46
S828 P47
S860 P48
S861 P49
S880 P50
S889 P51
COACH P66

ON/OFF ROAD

S909 P52
S911 P53
S913 P54
S917 P55
S918 P56
S929 P57
S951 P58

WINTER

SW01 P59
SW02 P60
SW03 P61
SW05 P62
SW06 P63

URBAN

CITY CONVOY P64

ABBREVIATIONS

Size	Size
Ply Rating	P.R.
Load Index	L.I.
Speed Rating	S.R.
Tread Depth (mm)	T.D.
Overall Diameter (mm)	O.D.
Section Width (mm)	S.W.
Rim Width (in)	RIM
Static Load Radius (in)	S.L.R.
Load Carrying Capacity@kpa (kg)	L.C.C.
Air Pressure (kpa)	A.P.

Why Choose Sailun?

Are you a distributor looking to add greater value to your line-up? Look no further than the quality engineered Sailun products to help benefit your brand line-up.

Because



Category Leader

Sailun is the
18th
largest tire manufacturer in the world.



Full Product Line

It is Sailun's main focus to develop products that are customer-lead and market oriented, which ensures they meet customer requirements. Through this process we have developed a full line of quality PLT, TBR, and OTR tire products that have been proven to perform in any conditions.



Quality Manufacturing

Quality Assurance and Quality Control are required when developing a product built to keep people safe. That is why Sailun only uses equipment from industry leading suppliers and a self-developed manufacturing process control system to ensure product quality.



Great Brand Value

Value doesn't stop at the quality of our products, it is also ingrained throughout the tire life cycle. Our mission is to generate the greatest value possible to all stakeholders at every stage of the process, and this ethos is incorporated into R&D, production, logistics, sales, and marketing.



Research & Development

This is where Sailun products are born. Our 30% annual investment of revenue is geared towards improving our testing capabilities, equipment, and empowering our engineering teams in Europe, North America, and Vietnam.



Excellence in Channel Support

"Think Global, Act Local": Sailun maintains dedicated support centers around the world staffed with tire industry professionals to help service customers locally.



Important Tips for Optimal Tire Performance:

- 1 Maintain optimum air pressure
- 2 Inspect tread grooves to ensure tires are safe and legal
- 3 Visually check for tire damage

Ensure you check your tires once a month and before long trips to maintain performance and ensure safety.

Why is it important I have the correct tire pressure?

A tire at optimum air pressure will ensure your safety, provide greater driving performance, improve tire life and reduce fuel consumption. Mileage, environment, and temperature changes all affect the pressure of your tires. An over-inflated tire will increase tire stiffness which influences driving comfort and can cause unnecessary reverberations. This can also increase the probability of tire damage and accelerate tread wear.

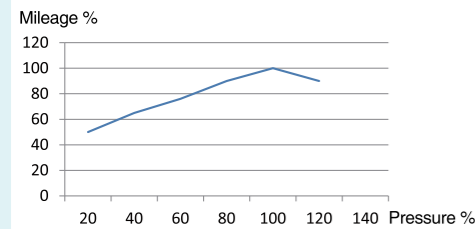

Note: Statistics are from the China National Rubber Tire Quality Supervision and Inspection Center <<Vehicle Tire Usage and Case Analysis>>

Where do I find the optimum tire pressure for my vehicle?

Tire sidewalls conveniently provide recommended tire pressure levels. Maintaining proper tire pressure is the most important way to extend the life and durability of your tires. Under-inflation is the main reason for a majority of serious tire ruptures, delamination, or punctures. A low tire pressure can reduce the load bearing capabilities of a tire, increase shoulder wear, cause excessive bending in the sidewall, and reduce rolling resistance resulting in overheating or internal damage.

How do I check my tire pressure?

- 1) Make sure to purchase a certified air pressure gauge.
- 2) Tires must be checked in a "cold" state (at least three hours after driving).
- 3) Insert the gauge into the valve.
- 4) Compare the measured air pressure level with the optimum tire pressure.



Why is it Important I Check for Tire Wear?

When the tread depth of your tire reaches 1.6mm, be sure to replace or re-tread them immediately. All new tires have a wear mark indicator, and when the tread is finally moved down to that level, the smooth surface of the tread groove will reveal the wear mark. Most of the accidents in wet weather are caused by worn-out tires, while excessive wear is also more likely to cause punctures.

Why is it Important I Check for Tire Damage?

A tire with any signs of damage is susceptible to tire separation, puncturing, etc.; therefore it is extremely important to often check for signs of damage on your tires (at least once a month). If in doubt, let a tire dealer check for you. If you find an abnormal damage, wear, ruptures, bulges, or leaks you should immediately remove the tire for inspection. Do not do any temporary repairs or use the inner tube to substitute for correct/certified repairs.

Do Not Overload Your Vehicle

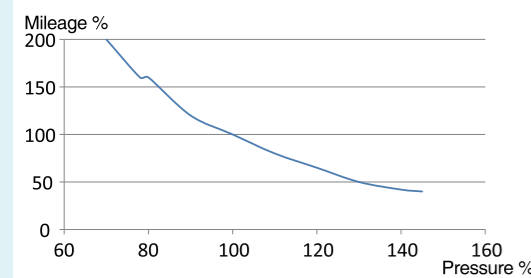

To know your vehicle loading limits, check the owner's manual. Over-loaded vehicles will cause tires and other parts of the vehicle will take on additional pressure. This will reduce handling, fuel economy, and possibly cause tire failure. An overloaded tire is also susceptible to serious ruptures, component separation or punctures. The load capacity of the new tire should not be lower than the capacity marked on the tire label, and remember that the optimum rim width is critical to proper load distribution and tire performance. When used on light trucks, multipurpose vehicle or trailers, the maximum load capacity marked on the sidewall of the tire should be reduced by 10%

Note: Statistics are from the China National Rubber Tire Quality Supervision and Inspection Center <<Vehicle Tire Usage and Case Analysis>>

Suspension Maintenance, Wheel Positioning and Dynamic Balancing, and Tire Rotation

Non-periodic tire replacement, suspension parts wear, dynamic balance, misalignment all will lead to excessive vibration or uneven wear. Tire rotation should be done according to the recommendations of the vehicle manufacturer, or at least every 10,000 km.

Truck / Bus Tire Rotation Diagram

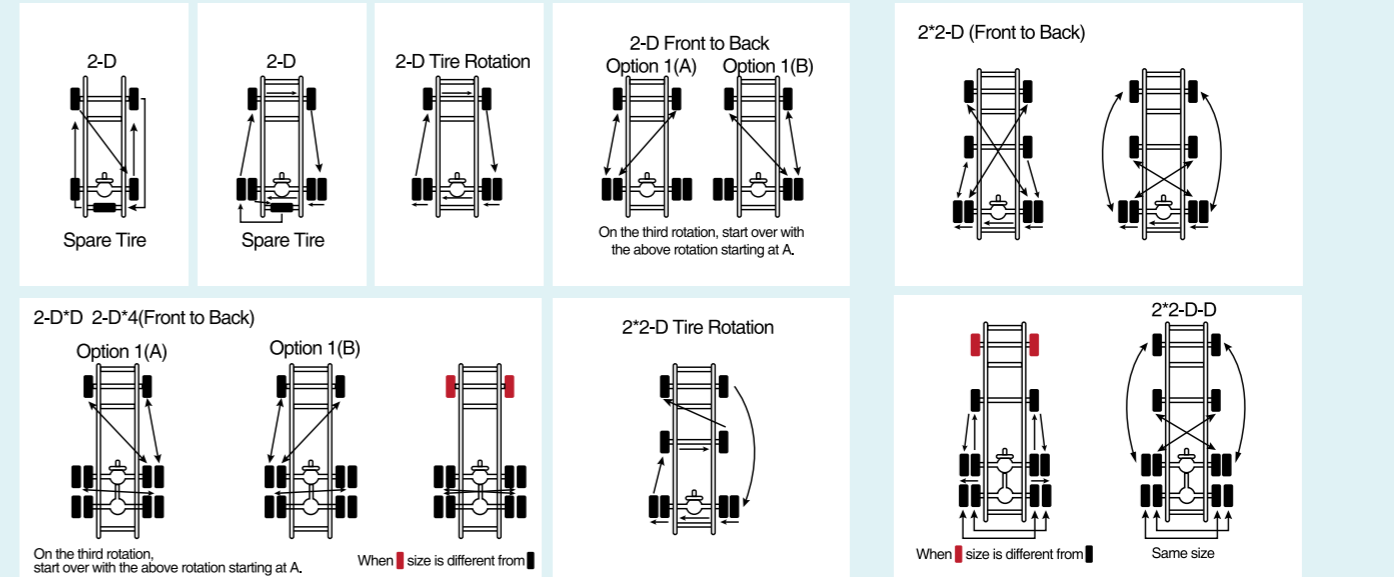

The Importance of Tire Replacement

A timely tire replacement is critical to driver safety and also influences vehicle lifespan and performance. You should replace a tire if you see any tire erosion or problems that are impossible to repair.

Warning

Before replacing the tires, be sure to refer to the owner's manual and follow the advice of the vehicle manufacturer regarding the replacement of the tires. Replacing the size or type of tires will seriously affect the vehicle's operating and safety performance. When selecting other tires that are different from the originally installed tires, consult a professional installer to ensure that the appropriate installation spacing, load capacity and inflation pressure are selected. You should not exceed the maximum load and inflation pressure marked on the sidewall of the tire. When replacing tires, you must use tires with the same outer diameter and load capacity. Make sure to adjust the inflation pressure to avoid overloading your tires. For correct load and inflation data, see the Tire and Rim Association's Load and Inflation Tables, ETRTO or JATMA standards.

Tire Storage Methods

Before putting your tire(s) in storage, check for signs of abrasion and/or damage and store according to the following directions.



User information for truck and bus tire

1. Always deflate the tire completely before removing lugs or side rings.
2. Never use rim parts of different manufacturers or different sizes.
3. Never mount tires on rims which are damaged or not smooth and clean.
4. Always clean and inspect the rim. Lubricate beads and rim flanges for tubeless tires. tube and rim side of flap with an approved rubber lubricant.
5. Always be sure that rim components are properly seated before inflating.

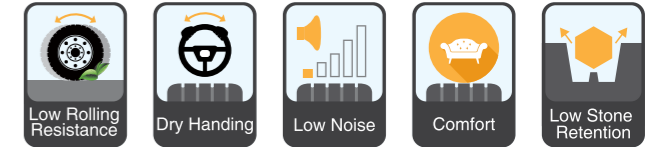
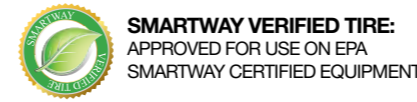
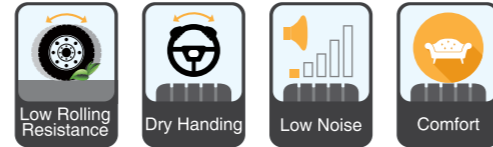

The S605 is Sailun's premium long-haul steer tire, featuring a decoupling groove and five wide ribs for a stable ride at all speeds. Stone ejectors minimize tire damage, while extra-wide grooves and S-sipes effectively disperse water for excellent hydroplaning resistance.

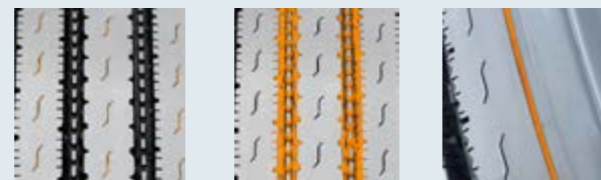

Features & Benefits:

- SmartWay® Verified - approved for use on EPA SmartWay® certified equipment.
- S-sipes improve traction in wet conditions and allow the tire to run cool to provide a longer tread life.
- Unique tread wall bite edges reduce irregular wear and improve traction.
- Stone ejectors reduce stone retention.
- Decoupling groove helps to minimize irregular wear.

Size	L.I. / S.R.	P.R.	T.D. mm	RIM inch	O.D. mm	S.W. mm	S.L.R. inch	L.C.C.		
								Single kg	Dual kg	A.P. kPa
11R22.5	144/142M	14	14.0	8.25	1054	279	19.3	2800	2650	720
	146/143M	16	14.0	8.25	1054	279	19.3	3000	2725	830
	148/145M	16	14.0	8.25	1054	279	19.3	3150	2900	850
11R24.5	146/143M	14	14.0	8.25	1104	279	20.3	3000	2725	720
	149/146M	16	14.0	8.25	1104	279	20.3	3250	3000	830
295/75R22.5	144/141M	14	14.0	9.00	1014	298	18.7	2800	2575	760
	146/143M	16	14.0	9.00	1014	298	18.7	3000	2725	830
285/75R24.5	144/141M	14	14.0	8.25	1050	283	19.4	2800	2575	760
	147/144M	16	14.0	8.25	1050	283	19.4	3075	2800	830



The S606 is Sailun's premium steer tire, featuring extra wide shoulders with built in sipes for excellent stability and traction under all weather conditions. An extra deep 22/32" tread depth ensures the S606 delivers exceptional mileage, while an interlocking symmetrical tread block design promotes even wear and a square footprint.

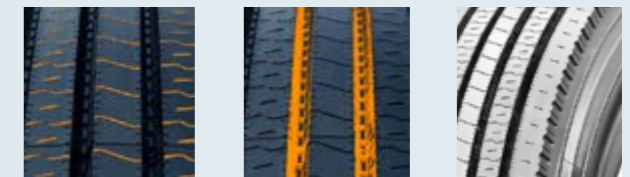

Features & Benefits:

- Multiple sipes improve traction in wet conditions and help the tire run cool to provide a longer tread life.
- Unique tread wall grooves help reduce irregular wear and improve traction.
- Stone ejectors reduce stone retention.
- Extra deep tread pattern (22/32") with special compound for extended tread life.
- Wide footprint and square shoulder design for improved stability and mileage.

Size	L.I. / S.R.	P.R.	T.D. mm	RIM inch	O.D. mm	S.W. mm	S.L.R. inch	L.C.C.		
								Single kg	Dual kg	A.P. kPa
11R22.5	144/142L	14	17.0	8.25	1054	279	19.3	2800	2650	720
	146/143L	16	17.0	8.25	1054	279	19.3	3000	2725	830
	148/145M	16	17.0	8.25	1054	279	19.3	3150	2900	850
12R22.5	152/148M	16	17.0	9.00	1085	300	19.8	3550	3150	850
	146/143L	14	17.0	8.25	1104	279	20.3	3000	2725	720
11R24.5	149/146L	16	17.0	8.25	1104	279	20.3	3250	3000	830
	146/143K	16	16.0	7.5	1054	278	19.1	3000	2725	830
10.00R20	149/146K	18	16.0	7.5	1054	278	19.1	3250	3000	930
	152/148L	16	15.0	9.00	1080	305	18.6	3350	3150	800
305/75R24.5	154/149L	18	15.0	9.00	1080	305	18.6	3750	3250	850
315/70R22.5	154/150L	18	16.0	9.00	1014	312	18.5	3750	3350	900
315/80R22.5	156/150L (154/150M)	18	15.5	9.00	1076	312	19.69	4000	3350	850
	144/141L	14	17.0	9.00	1014	298	18.7	2800	2575	760
295/75R22.5	144/141L	14	17.0	9.00	1014	298	18.7	2800	2575	760
	152/148M	16	17.0	9.00	1044	298	19.2	3550	3150	850
295/80R22.5	157/154K	20	16.0	9.00	1076	312	19.7	4125	3750	900
	156/150L (154/150M)	18	16.0	9.00	1076	312	19.7	4000	3350	850
285/75R24.5	144/141L	14	17.0	8.25	1050	283	19.4	2800	2575	760
LT215/85R16	120/118L	14	10.0	6.0J	772	216	14.1	1400	1320	650
11R24.5	149/146M	16	17.0	8.25	1104	279	20.31	3250	3000	830
11R22.5	146/143M	16	17.0	8.25	1054	279	19.33	3000	2725	830
11R24.5	146/143M	14	17.0	8.25	1104	279	20.31	3000	2725	720
11R22.5	144/142M	14	17.0	8.25	1065	279	19.33	2800	2650	720

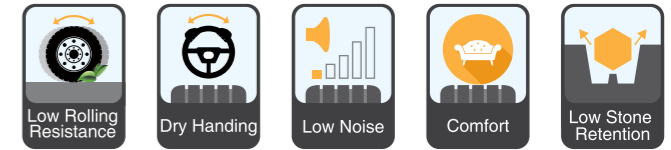
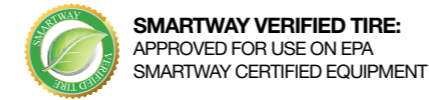

The S607 is a premium regional steer tire, designed with extra wide shoulders that resist curbing damage and stone ejector buttons to reduce stone retention. Full-length sipes built into tread blocks effectively channel water for exceptional wet traction. The S607 is a versatile tire, suitable on all regional applications such as delivery trucks, buses, and concrete trucks.



Features & Benefits:

- 5-rib design and wide shoulders for improved stability.
- Tread profile designed to reduce rolling resistance and improve fuel economy for greater stability and mileage.
- Interlocking multi-sipes improve traction in wet conditions and increase stability.

Size	L.I. / S.R.	P.R.	T.D.	RIM	O.D.	S.W.	S.L.R.	L.C.C.		
								Single	Dual	A.P.
			mm	inch	mm	mm	inch	kg	kg	kPa
295/80R22.5	152/148M	16	15.0	9.00	1044	298	19.2	3550	3150	850
315/80R22.5	156/150L	18	15.5	9.00	1076	312	19.7	4000	3350	850
	161/157G	20	15.5	9.00	1076	312	19.7	4625	4125	900



The S622 is a premium free-rolling trailer position tire. With a decoupling groove that resists irregular sidewall wear, and wide ribs to prevent damage caused by high-scrub applications. The S622 is also a low-rolling resistance tire designed to maximize your mileage.

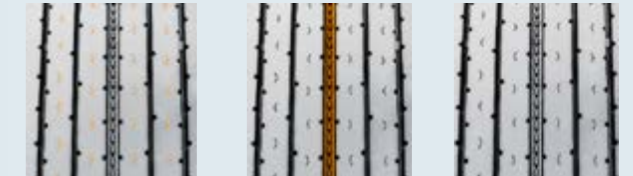

Features & Benefits:

- V-sipes improve traction in wet conditions and dissipate heat for prolonged tread life.
- Main groove stone ejectors reduce stone retention.
- 5 deep grooves allow for excellent traction in wet and dry conditions.

Size	L.I. / S.R.	P.R.	T.D.	RIM	O.D.	S.W.	S.L.R.	L.C.C.		
								Single	Dual	A.P.
			mm	inch	mm	mm	inch	kg	kg	kPa
11R22.5	144/142M	14	9.5	8.25	1054	279	19.3	2800	2650	720
11R24.5	146/143M	14	9.5	8.25	1104	279	20.3	3000	2725	720
255/70R22.5	140/137L	16	11.0	7.50	930	255	17.1	2500	2300	830
295/75R22.5	144/141M	14	9.5	9.00	1014	298	18.7	2800	2575	760
285/75R24.5	144/141M	14	9.5	8.25	1050	283	19.4	2800	2575	760

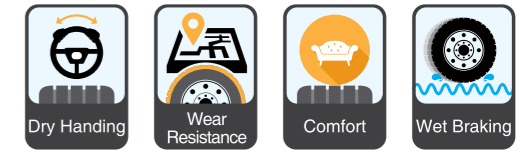

The S626 is designed with a special tread rubber that allows for cool running and improved scrub resistance. The tread also employs four zigzag grooves for greater wet traction, an even ground contact pressure distribution to prevent irregular wear, and superior maneuverability and comfort.

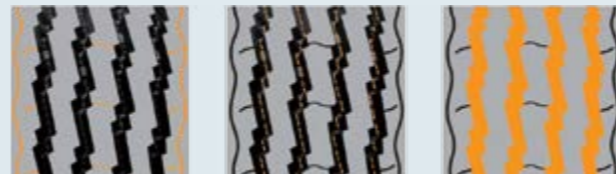

Features & Benefits:

- Small wave-like grooves and slits provide great heat dissipation and strong grip performance on wet and dry roads.
- Stone ejectors set at the bottom of the grooves help reduce stone retention.
- Four main zigzagged grooves provide good directional stability, improve scrub resistance, and efficiently drain water.

Size	L.I. / S.R.	P.R.	T.D. mm	RIM inch	O.D. mm	S.W. mm	S.L.R. inch	L.C.C.		
								Single kg	Dual kg	A.P. kPa
11R22.5	148/145L	16	13.5	8.25	1054	279	19.3	3250	2900	850



The S628 is suitable for mid to long distance trucks and busses traveling on highways and normal roads. Four main tread grooves offer great handling stability and driving comfort. The balanced shoulder design improves heat dissipation and while also providing great high speed performance. Advanced tread wear formula increase scrub resistance.



Features & Benefits:

- Fine grooves located in the ribs provide good heat dissipation, strong grip, and improved skid resistance.
- The optimized tread arc design produces low rolling resistance and enhances fuel efficiency
- Four pattern grooves improve handling stability and driving comfort.
- The shoulder groove design is optimized to improve heat dissipation and reduce irregular shoulder wear.

Size	L.I. / S.R.	P.R.	T.D. mm	RIM inch	O.D. mm	S.W. mm	S.L.R. inch	L.C.C.		
								Single kg	Dual kg	A.P. kPa
12R22.5	152/149M	18	15.0	9.00	1085	300	19.8	3550	3250	930
295/80R22.5	152/148M	16	15.0	9.00	1044	298	19.2	3550	3150	850



The S629 is a directional position tire suitable for mid to long distance trucks and busses running on good roads. Tread compound formula improves scrub resistance. Unique shoulder design and deeper shoulder grooves help prevent abnormal tire wear. Widened running surface provides better tread-to-ground contact area for improved handling.



Features & Benefits:

- Shallow pattern grooves provide the tire with strong grip and skid resistance.
- The widened running surface provides even contact pressure for better handling.
- Zigzag pattern at the bottom of the tread grooves provide for better maneuverability and driving comfort.
- The widened shoulder and unique shoulder groove design provide for cool running and reduce uneven wear.

Size	L.I. / S.R.	P.R.	T.D. mm	RIM inch	O.D. mm	S.W. mm	S.L.R. inch	L.C.C.		
								Single kg	Dual kg	A.P. kPa
11R22.5	144/142M	14	15.0	8.25	1054	279	19.3	2800	2650	720
	146/143M	16	15.0	8.25	1054	279	19.3	3000	2725	830
	148/145M	16	15.0	8.25	1054	279	19.3	3150	2900	850
12R22.5	152/148M	16	15.0	9.00	1085	300	19.8	3550	3150	850
11.00R20	150/147L	16	15.5	8.00	1085	293	19.7	3350	3075	830
385/55R22.5	160K(158L)	20	14.5	12.25	996	386	18.3	4500	--	900
295/60R22.5	150/147L	18	15.0	9.00	926	292	17.0	3350	3075	900
315/60R22.5	152/148L	18	15.0	9.75	950	313	17.4	3550	3150	900
285/70R19.5	146/144L	16	13.0	8.25	895	283	16.2	3000	2800	900
	(144/142M)									
315/70R22.5	152/148M	16	16.0	9.00	1014	312	18.5	3550	3150	850
	154/150L	18	16.0	9.00	1014	312	18.5	3750	3350	900
	156/150L	18	16.0	9.00	1014	312	18.5	4000	3350	900
295/80R22.5	150/147M	16	16.5	9.00	1044	298	19.2	3350	3075	830
	152/148M	16	16.5	9.00	1044	298	19.2	3350	3000	800
	152/149M	18	16.5	9.00	1044	298	19.2	3550	3250	900
	154/149M	18	16.0	9.00	1044	298	19.2	3750	3250	850
315/80R22.5	154/150M	16	17.0	9.00	1076	312	19.7	3750	3350	825
	156/150L	18	17.0	9.00	1076	312	19.7	4000	3350	850
	(154/150M)									
157/154L	20	16.5	9.00	1076	312	19.7	4125	3750	900	



The SFR1 is a directional position tire suitable for mid to long distance trucks and busses running on good roads. Tread compound formula improves scrub resistance. Unique shoulder design and deeper shoulder grooves help prevent abnormal tire wear. Widened running surface provides better tread-to-ground contact area for improved handling.



Features & Benefits:

- Shallow pattern grooves provide the tire with strong grip and skid resistance.
- The widened running surface provides even contact pressure for better handling.
- Zigzag pattern at the bottom of the tread grooves provide for better maneuverability and driving comfort.
- The widened shoulder and unique shoulder groove design provide for cool running and reduce uneven wear.

Size	L.I. / S.R.	P.R.	T.D. mm	RIM inch	O.D. mm	S.W. mm	S.L.R. inch	L.C.C.		
								Single kg	Dual kg	A.P. kPa
385/65R22.5	158L	18PR	16	11.75	1072	389	19.45	4250		830
385/65R22.5	160K(158L)	20PR	16	11.75	1072	389	19.45	4500		900
385/65R22.5	164K(158L)	20PR	16	11.75	1072	389	19.45	5000		900

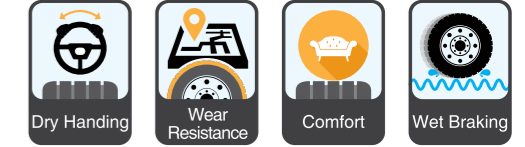
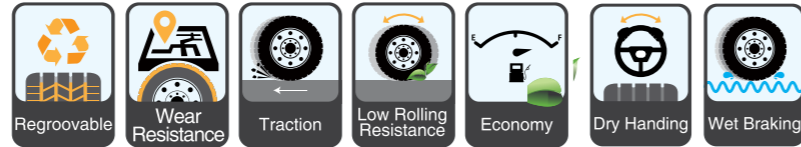

Trailer position pattern suitable for mid-to-long distances on good roads. Specialized tread rubber formula improves wear resistance and rolling resistance. Unique shoulder design prevents uneven wear.



Features & Benefits:

- Horizontal block grooves improve grip and slip resistance.
- Four main tread grooves provide excellent handling and driving comfort.
- Widened shoulder prevents irregular shoulder wear.



The S636's balanced inner contour is designed to greatly improve the tire's durability. The tread rubber compound effectively reduces heat generation and improves wear resistance of the tread and shoulder for increased mileage.

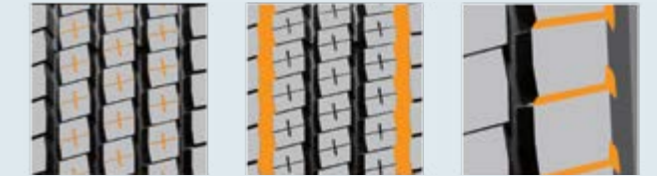

Features & Benefits:

- Fine grooves located in the ribs provide good heat dissipation, strong grip, and improved skid resistance.
- Slight modifications in the shoulder design effectively reduces uneven wear.
- Four pattern grooves improve maneuverability.
- The widened running surface and deep groove pattern design effectively enhance scrub resistance for increased mileage.

Size	L.I. / S.R.	P.R.	T.D.	RIM	O.D.	S.W.	S.L.R.	L.C.C.			
								mm	inch	mm	mm
385/65R22.5	158L	18PR	16	11.75	1072	389	19.45	4250			830
385/65R22.5	160K(158L)	20PR	16	11.75	1072	389	19.45	4500			900
385/65R22.5	164K(158L)	20PR	16	11.75	1072	389	19.45	5000			900

Size	L.I. / S.R.	P.R.	T.D.	RIM	O.D.	S.W.	S.L.R.	L.C.C.			
								mm	inch	mm	mm
10.00R20	149/146L	18	16.0	7.5	1054	278	19.1	3250	3000		930
11.00R20 <i>SUPER</i>	150/147L	16PR	14.0	8.0	1085	293	19.65	3350	3075		830
11.00R20 <i>SUPER</i>	152/149L	18PR	14.0	8.0	1085	293	19.65	3550	3250		930

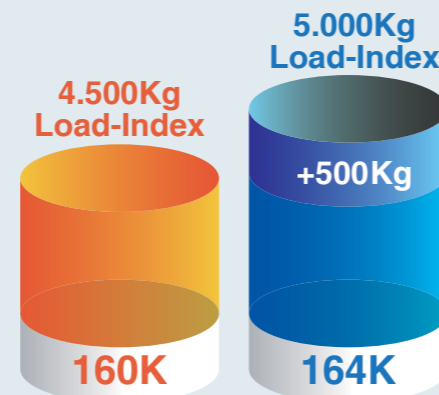
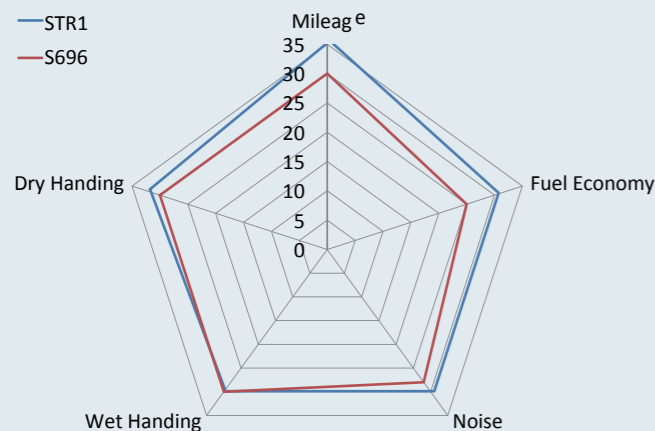



The S637 is a versatile all-position tire for regional use featuring five extra-wide ribs for exceptional stability. An extra-wide solid tread fairs well during high-scrub applications and the mirrored tread design ensures uniform tread wear. Wide grooves effectively improve wet performance while the special tread compound improves tread life.

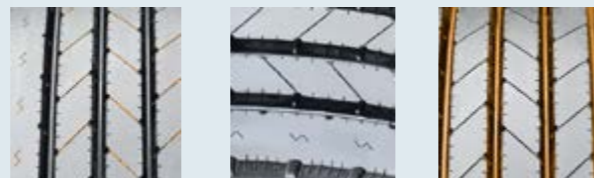

Features & Benefits:

- Tread sipes improve traction in wet conditions and allow the tire to run cool to extend tread life.
- Shallow tread design reduces rolling resistance for better fuel economy.
- Unique tread wall grooves and sipes help reduce irregular wear

Size	L.I. / S.R.	P.R.	T.D.	RIM	O.D.	S.W.	S.L.R.	L.C.C.		
								Single	Dual	A.P.
								mm	kg	kPa
9.5R17.5	129/127M	14	13.5	6.75	842	240	15.6	1850	1750	750
	132/130M	16	13.5	6.75	842	240	15.6	2000	1900	830
	143/141J	18	13.5	6.75	842	240	15.6	2725	2575	875
8R22.5	130/128M	14	13.0	6.00	935	203	17.3	1900	1800	830
9R22.5	136/134M	14	14.0	6.75	974	229	18.0	2240	2120	830
10R22.5	141/139M	14	14.5	7.50	1019	254	18.7	2575	2430	790
11R22.5	148/145M	16	12.5	8.25	1054	292	19.3	3150	2900	850
245/70R17.5	143/141J	18	13.0	7.50	789	248	14.4	2725	2575	875
215/75R17.5	135/133L	16	12.5	6.00	767	211	14.2	2180	2060	860
235/75R17.5	143/141L	16	13.0	6.75	797	233	14.7	2725	2575	860
225/70R19.5	128/126L	14	12.5	6.75	811	226	15.4	1800	1700	760
	245/70R19.5	133/131M	14	13.0	839	248	15.4	2060	1950	750
245/70R19.5	144/142J	18	13.0	7.5	839	248	15.4	2800	2650	900
	265/70R19.5	140/138M	16	13.5	867	262	15.8	2500	2360	775
255/70R22.5	140/137M	16	14.0	7.50	930	255	17.1	2500	2300	800
	140/137L	16	14.0	7.50	930	255	17.1	2500	2300	830
275/70R22.5	148/145M	16	15.0	8.25	958	276	17.6	3150	2900	900
295/75R22.5	144/141M	14	13.0	9.00	1014	298	18.7	2800	2575	760
ST235/80R16	129/125L	14	8.00	6 1/2J	782	235	13.9	1850	1650	760
ST235/85R16	129/125L	14	9.00	6 1/2J	806	235	14.3	1850	1650	760



The S637+ is a versatile all-position tire for regional use featuring five extra-wide ribs for exceptional stability. An extra-wide solid shoulder resist damage during high-scrub applications, while a mirrored tread design ensures even tread wear. Wide grooves effectively improve wet performance while the special tread compound improves tread life.

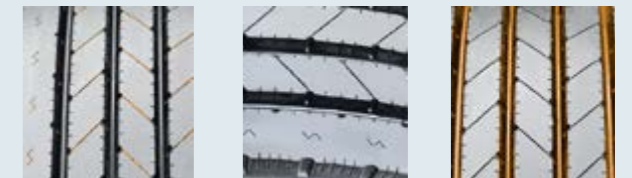

Features & Benefits:

- Tread sipes improve traction in wet conditions and allow the tire to run cool to extend tread life.
- Shallow tread design reduces rolling resistance for better fuel economy.
- Unique tread wall grooves and sipes help reduce irregular wear.

Size	L.I. / S.R.	P.R.	T.D.	RIM	O.D.	S.W.	S.L.R.	L.C.C.		
								Single	Dual	A.P.
								mm	kg	kPa
9.5R17.5	129/127M	14	13.5	6.75	842	240	15.6	1850	1750	750
	132/130M	16	13.5	6.75	842	240	15.6	2000	1900	830
	143/141J	18	13.5	6.75	842	240	15.6	2725	2575	875
10R22.5	141/139M	14	14.5	7.50	1019	254	18.8	2575	2430	790
245/70R17.5	143/141J	18	13.0	7.50	789	248	14.4	2725	2575	875
205/75R17.5	124/122M	14	13.0	6.00	753	205	13.9	1600	1500	750
215/75R17.5	126/124M	14	13.0	6.00	767	211	14.2	1700	1600	700
	135/133L	16	13.0	6.00	767	211	14.2	2180	2060	860
235/75R17.5	143/141L	16	13.5	6.75	797	233	14.7	2725	2575	860
	132/130M	14	13.5	6.75	797	233	14.7	2000	1900	760
225/70R19.5	128/126L	14	12.5	7.50	811	226	15.4	1800	1700	760
245/70R19.5	133/131M	14	13.0	7.50	839	248	15.39	2060	1950	760
265/70R19.5	140/138M	14	13.5	7.50	867	262	15.8	2500	2360	775
	143/141J	18	13.5	7.50	867	262	15.8	2725	2575	900
285/70R19.5	146/144M	16	13.5	8.25	895	283	16.3	3000	2800	900
	150/148K	18	13.5	8.25	895	283	16.3	3350	3150	900
255/70R22.5	140/137M	16	13.5	7.50	930	255	17.12	2500	2300	800
275/70R22.5	148/145L	16	14.5	8.25	958	275	17.56	3150	2900	900
275/70R22.5	148/145M	16	14.5	8.25	958	275	17.56	3150	2900	900
225/80R17.5	123/122M	14PR	15.5	6.75	805	226	14.72	1550	1500	700

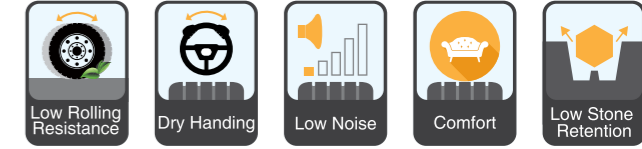
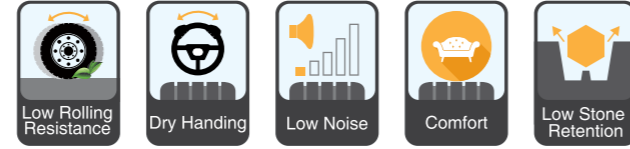

The S665 is designed for trucks and busses driving on highway and normal roads. Four main pattern grooves improve handling and driving comfort. The contour design of the tread reduces heat build up, allowing the tire to run cool, and improves high speed performance. New tread formula offers greater scrub resistance.

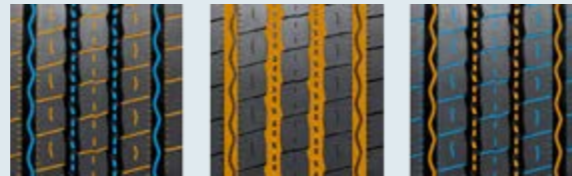

Features & Benefits:

- The horizontal tread grooves efficiently drain water for better hydroplaning resistance.
- Four main pattern grooves improve handling and driving comfort.
- Small grooves located at the bottom of the main tread grooves reduce stone retention.

Size	L.I. / S.R.	P.R.	T.D.	RIM	O.D.	S.W.	S.L.R.	L.C.C.		
								mm	inch	mm
11R22.5	144/142M	14	15.0	8.25	1054	279	19.3	2800	2650	720
	146/143M	16	15.0	8.25	1054	279	19.3	3000	2725	830
	148/145M	16	15.0	8.25	1054	279	19.3	3150	2900	850
11R24.5	146/143M	14	15.0	8.25	1104	279	20.3	3000	2725	720
	149/146M	16	15.0	8.25	1104	279	20.3	3250	3000	830
295/75R22.5	144/141M	14	15.0	9.00	1014	298	18.7	2800	2575	760
	146/143M	16	15.0	9.00	1014	298	18.7	3000	2725	830
285/75R24.5	144/141M	14	15.0	8.25	1050	283	19.4	2800	2575	760
	147/144M	16	15.0	8.25	1050	283	19.4	3075	2800	830



S668 is suitable for mid to long distance trucks and busses traveling on highways and normal roads.

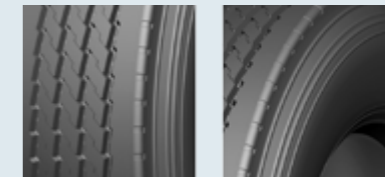

Features & Benefits:

- Four main grooves improve driving stability.
- Unique shoulder design improves uniform tread wear.

Size	L.I. / S.R.	P.R.	T.D.	RIM	O.D.	S.W.	S.L.R.	L.C.C.		
								mm	inch	mm
11R22.5	144/142M	14	13.5	8.25	1054	279	19.3	2800	2650	720
	146/143M	16	13.5	8.25	1054	279	19.3	3000	2725	830
11R24.5	149/146M	16	13.5	8.25	1104	279	20.3	3250	3000	830
	146/143M	14	13.5	8.25	1104	279	20.3	3000	2725	720
295/75R22.5	144/141M	14	13.5	9.00	1014	298	18.7	2800	2575	760
	146/143M	16	13.5	9.00	1014	298	18.7	3000	2725	830
255/70R22.5	140/137L	16	13	7.50	930	255	17.13	2500	2300	830



The S696 is a low section tire designed to replace the traditional double-tire style. The special tread rubber design allows the tire to run cool. Strengthened design improves driving safety.

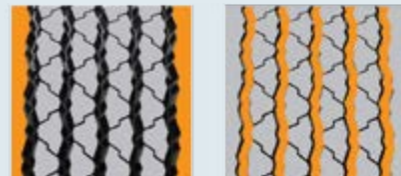

Features & Benefits:

- Small grooves allow the tire to run cool and provide better grip to improve skid resistance.
- Closed-shoulder design enhances tread wear resistance and effectively uneven wear.
- Zigzagged grooved reduce stone retention.
- Super wide running surface, shoulder design, and special tread formula improve tread life.

Size	L.I. / S.R.	P.R.	T.D.	RIM	O.D.	S.W.	S.L.R.	L.C.C.		
								mm	inch	mm
6.50R16LT	110/105M	12	10.5	5.50F	750	185	13.8	1060	925	670
8.25R16LT	128/124L	16	13.5	6.50H	855	235	15.6	1800	1600	770
7.00R16LT	115/110M	12	11.5	5.50F	775	200	14.3	1215	1060	670
	118/114L	14	11.5	5.50F	775	200	14.3	1320	1180	770
7.50R16LT	122/118L	14	12.5	6.00G	805	215	14.8	1500	1320	770
445/45R19.5	160J	20	13.5	15.00	895	446	16.4	4500	—	900
435/50R19.5	160J	20	13.0	14.00	931	438	16.9	4500	—	900
7.50R20	130/128L	14	13.5	6.0	935	215	17.1	1900	1800	830
385/55R22.5	160K(158L)	20	15.0	12.25	996	386	18.2	4500	—	900
385/65R22.5	158L	18	15.5	11.75	1072	389	19.5	4250	—	830
	160K	20	15.5	11.75	1072	389	19.5	4500	—	900
445/50R22.5	161M	20	10.5	14.00	1018	445	18.7	4625	—	830
ST225/90R16	130/126L	14	12.5	6J	808	220	14.76	1895	1695	760
ST225/90R16	127/123L	12	12.5	6J	808	220	14.76	1750	1550	655



The S698 employs a rubber formulation which increases the strength of the tread and shoulder for improved tear and scrub resistance, as well as promotes uniform tread wear. The knobs at the bottom of each groove reduce stone retention.

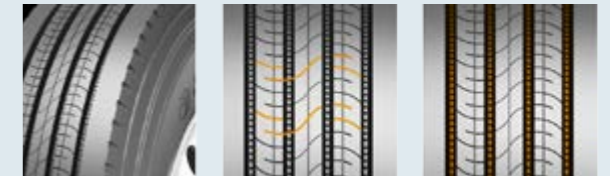

Features & Benefits:

- Improved contact shape helps to resist against irregular wear.
- Small groove channels reduce noise resonance for a more comfortable drive.
- Four main tread grooves are designed to effectively drain water for improved wet performance.
- Tear resistant.
- High scrub resistance.
- Cool running.

Size	L.I. / S.R.	P.R.	T.D.	RIM	O.D.	S.W.	S.L.R.	L.C.C.		
								mm	inch	mm
385/65R22.5	158L	18	13.5	11.75	1072	389	19.5	4250	--	830
	160K	20	13.5	11.75	1072	389	19.5	4500	--	900
315/80R22.5	154/151M	18	14.0	9.00	1076	312	19.5	3750	3450	830
	156/153L	20	14.0	9.00	1076	312	19.5	4000	3650	850

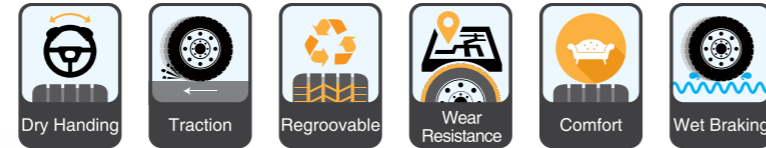

The S701 is a drive-position tire for long-distance transportation applications. The specialised rubber tread compound provides excellent anti-scrub resistance. The varied pitch tread design and narrow horizontal grooves effectively reduce tire noise for a more comfortable ride.



Features & Benefits:

- Three main tread grooves provide excellent handling stability for a more comfortable ride.
- Widened tread-to-road contact surface evens out pressure for improved driving stability.
- Narrow grooves are optimized to reduce noise emissions.

Size	L.I. / S.R.	P.R.	T.D. mm	RIM inch	O.D. mm	S.W. mm	S.L.R. inch	L.C.C.		
								Single	Dual	A.P.
								kg	kg	kPa
295/60R22.5	150/147L	18	17.5	9.00	926	292	17.0	3350	3075	900
315/60R22.5	152/148L	18	18.5	9.75	950	313	17.4	3550	3150	900
315/70R22.5	152/148M	16	18.5	9.00	1014	312	18.5	3550	3150	850
	154/150L	18	18.5	9.00	1014	312	18.5	3750	3350	900
295/80R22.5	152/148M	16	17.5	9.00	1044	298	19.2	3350	3000	800
	154/150M	16	18.5	9.00	1076	312	19.7	3750	3350	825
315/80R22.5	156/150L	18	18.5	9.00	1076	312	19.7	4000	3350	850
	156/150L (154/150M)	18	18	9.00	1082	312	19.69	4000	3350	850



The S705 is a drive position tire suitable for long-distance transportation applications on highway and normal roads. The tread formula improves tire strength, wear resistance, and ensures the tire runs cool.

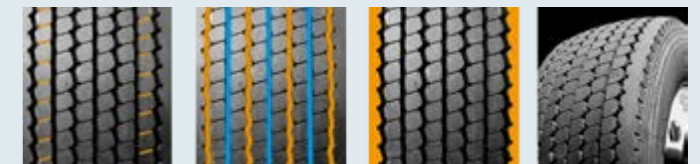

Features & Benefits:

- The grooves are notched for improved grip.
- Four zigzagged and three straight tread groove design provides excellent handling performance and grip while also reducing stone retention.
- The shoulder groove design and widened shoulder make sure the tire runs cool to reduce irregular shoulder wear.
- Widened running surface and improved scrub resistance provide greater stability.

Size	L.I. / S.R.	P.R.	T.D. mm	RIM inch	O.D. mm	S.W. mm	S.L.R. inch	L.C.C.		
								Single	Dual	A.P.
								kg	kg	kPa
445/50R22.5	161L	20	20.5	14.00	1024	445	18.9	4625	--	830



The S702's optimized tread formula improves wear resistance by ensuring the tire runs cool. A rib between the pattern blocks help reduce partial wear and improve scrub resistance.

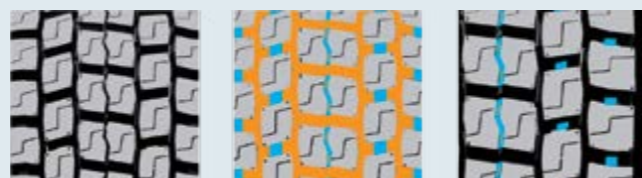

Features & Benefits:

- Widened tread grooves improve self-cleaning capabilities for grip.
- The rib between pattern blocks is designed to improve stiffness and reduce partial wear.
- Widened running surface allows for better driving stability.

Size	L.I. / S.R.	P.R.	T.D.	RIM	O.D.	S.W.	S.L.R.	L.C.C.		
								mm	inch	kPa
10.00R20	146/143K	16	18.0	7.5	1065	278	19.1	3000	2725	830
	149/146K	18	18.0	7.5	1065	278	19.1	3250	3000	930
11.00R20	150/147K	16	18.5	8.0	1096	293	19.7	3350	3075	830
	152/149K	18	18.5	8.0	1096	293	19.7	3550	3250	930
11R22.5	148/145L	16	20.0	8.25	1065	279	19.3	3150	2900	850
245/70R17.5	143/141J(146/146F)	18	15.5	7.50	789	248	14.4	2725	2575	875
205/75R17.5	124/122L	14	15.0	6.00	753	205	13.9	1600	1500	750
215/75R17.5	126/124M	14	15.0	6.00	767	211	14.2	1700	1600	700
235/75R17.5	132/130M	14	15.0	6.75	797	233	14.7	2000	1900	760
	143/141K	16	15.0	6.75	797	233	14.7	2725	2575	860
225/70R19.5	128/126L	14	15.0	6.75	811	226	15.4	1800	1700	760
245/70R19.5	136/134M	16	15.5	7.50	839	248	15.4	2240	2120	825
	144/142J	18	15.5	7.50	839	248	15.4	2800	2650	900

Size	L.I. / S.R.	P.R.	T.D.	RIM	O.D.	S.W.	S.L.R.	L.C.C.		
								mm	inch	kPa
265/70R19.5	137/134L	14	16.0	7.50	867	262	15.8	2300	2120	760
	140/138M	16	16.0	7.50	867	262	15.8	2500	2360	775
	143/141J	18	16.0	7.50	867	262	15.8	2725	2575	900
285/70R19.5	145/143M	16	16.5	8.25	895	283	16.3	2900	2725	850
275/70R22.5	148/145L	16	19	8.25	958	275	17.56	3150	2900	900
315/60R22.5	152/148L	18	20.5	9.75	950	313	17.6	3550	3150	900
315/70R22.5	152/148M	16	20.5	9.00	1014	312	18.5	3550	3150	850
	154/150L	18	20.5	9.00	1014	312	18.5	3750	3350	900
295/80R22.5	150/147M	16	22.5	9.00	1044	298	19.2	3350	3075	830
	152/148M	16	22.5	9.00	1044	298	19.2	3350	3000	800
	152/149L	18	22.5	9.00	1044	298	19.2	3550	3250	900
315/80R22.5	154/150M	16	23.0	9.00	1076	312	19.7	3750	3350	825
	154/151L	18	23.0	9.00	1082	312	19.7	3750	3450	830
	156/150L	18	23.0	9.00	1082	312	19.7	4000	3350	850
	157/154K	20	22.0	9.00	1082	312	19.7	4125	3750	900
	156/150L (154/150M)	18	21.5	9.00	1082	312	19.69	4000	3350	850



The S711 special tread design effectively improves self-cleaning capabilities and deepened grooves provide for a longer tread life.

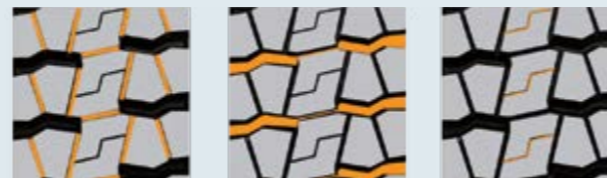

Features & Benefits:

- Narrow grooves reduce tread rigidity and improve scrub resistance.
- The depend zigzag grooves extending from the shoulder to the center improve grip.
- The small rib design between pattern blocks are designed to reduce the movement of the pattern blocks and reduce uneven tread wear.

Size	L.I. / S.R.	P.R.	T.D.	RIM	O.D.	S.W.	S.L.R.	L.C.C.		
								mm	inch	mm
8.25R20	139/137K	16	16.5	6.5	986	236	17.8	2430	2300	930
9.00R20	144/142K	16	17.0	7.0	1030	259	18.5	2800	2650	900
	146/143K	16	17.0	7.5	1065	278	19.1	3000	2725	830
10.00R20	149/146K	18	17.0	7.5	1065	278	19.1	3250	3000	930
	150/147K	16	18.0	8.0	1096	293	19.7	3350	3075	830
11.00R20	152/149K	18	18.0	8.0	1096	293	19.7	3550	3250	930
	154/151K	18	19.5	8.5	1125	315	20.31	3750	3450	830
13R22.5	154/151K	18	20.5	9.75	1124	320	20.5	3750	3450	830
	156/150K	18	20.5	9.75	1124	320	20.5	4000	3350	875
12.00R24	160/157K	20	19.5	8.5	1226	315	14.1	4500	4125	900
7.50R16LT	122/118K	14	15.0	6.00G	815	215	14.8	1500	1320	770
	156/150K	18	21.0	9.00	1082	312	19.8	4000	3350	850
	161/157G	18	21.0	9.00	1082	312	19.8	4625	4125	900
315/80R22.5	154/151L	18	21.0	9.00	1082	312	19.8	3750	3450	830
	157/154J	18	21.0	9.00	1082	312	19.8	4125	4125	900
	156/150K (158/156G)	18	20.5	9.00	1082	312	19.69	4000	3350	850
12.00R20	156/153K	20	19.5	8.50	1125	315	18.19	4000	3650	900
11R22.5	148/145L	16	22.0	8.25	1065	279	19.33	3150	2900	850



The S712's robust carcass provides maximum load-bearing capacity. It's special tread design effectively improves it's self-cleaning properties. It's deepened groove provides the tire with a super long mileage and balanced wear.

Size	L.I. / S.R.	P.R.	T.D.	RIM	O.D.	S.W.	S.L.R.	L.C.C.		
								mm	inch	mm
9.00R20	144/142J	16	16.0	7.0	1030	259	18.6	2800	2650	900
	146/144J	18	16.0	7.0	1030	259	18.6	3000	2800	970
10.00R20	149/146K	18	17.5	7.5	1065	278	19.2	3250	3000	930
11.00R20	152/149K	18	17.5	8.0	1096	293	19.7	3550	3250	930
12.00R20	154/151K	18	18.0	8.5	1125	315	20.31	3750	3450	830
	158/155J	22	18.0	8.5	1125	315	20.31	4250	3875	970
11R22.5	148/145L	16	17.5	8.25	1065	279	19.3	3150	2900	840

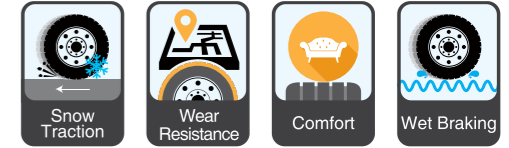

The S737 is specially designed for regional transportation. The six interlocking tread blocks and symmetrical design promote even wear for a longer tread life. Tapered grooves improve all-weather performance.



Features & Benefits:

- Integrated ribs reduce irregular wear and improve stability.
- Angled lug and sipe design improve overall traction and wet grip.
- M&S rated, all-weather lug tread design for regional applications.
- Optimized groove design for better self-cleaning capabilities and improved traction.

Size	L.I. / S.R.	P.R.	T.D.	RIM	O.D.	S.W.	S.L.R.	L.C.C.		
								mm	inch	mm
13R22.5	156/150K	18	20.5	9.75	1136	320	20.5	4000	3350	875
10.00R20	149/146K	18	18.0	7.5	1065	278	19.1	3250	3000	930
11.00R20	152/149K	18	20.0	8.0	1096	293	19.7	3550	3250	930
215/75R17.5	135/133L	16	14.5	6.00	773	211	14.2	2180	2060	860
225/70R19.5	128/126L	14	15.5	6.75	817	226	15.4	1800	1700	760
245/70R19.5	133/131L	14	16.5	7.50	845	248	15.4	2060	1950	760
	136/134M	16	16.5	7.50	845	248	15.4	2240	2120	825
315/70R22.5	154/150L	18	20.0	9.00	1020	312	18.5	3750	3350	900
295/80R22.5	152/149L	18	20.5	9.00	1050	298	19.2	3550	3250	900
315/80R22.5	156/150L	18	22.0	9.00	1082	312	19.7	4000	3350	850
	157/154L	20	22.0	9.00	1082	312	19.7	4125	3750	900
	156/150L (154/150M)	18	21.5	9.00	1082	312	19.69	4000	3350	850



The S740 boasts a widened tread for a larger tread-to-road contact area. This and the optimized contour design ensure pressure is spread evenly to prevent irregular wear. The winding sipes help improve performance in rain, snow, and ice.

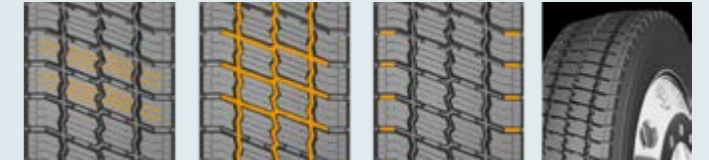

Features & Benefits:

- Winding sipes improve grip in snow and ice for greater driving safety.
- Groove design effectively improve traction.
- Ribs placed within the shoulder grooves improve scrub resistance.

Size	L.I. / S.R.	P.R.	T.D.	RIM	O.D.	S.W.	S.L.R.	L.C.C.		
								mm	inch	mm
225/70R19.5	128/126L	14	16.0	6.75	817	226	15.4	1800	1700	760
245/70R19.5	135/133L	16	16.0	7.50	845	248	15.4	2180	2060	830

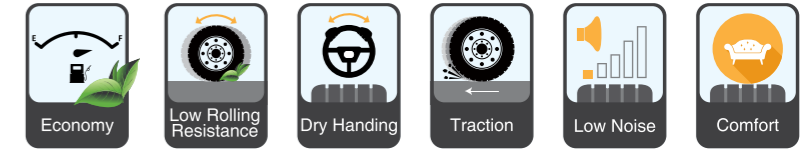
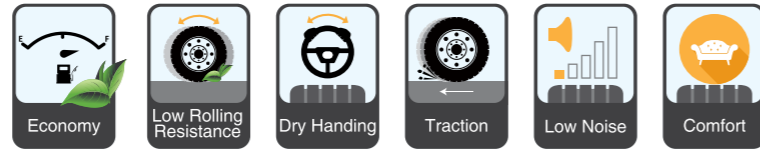

The S753 is a premium drive tire for regional and pickup applications. The interlocking tread block reduces stone retention and improve self-cleaning capabilities. Extra deep grooves (26/32") offer a longer tread life.

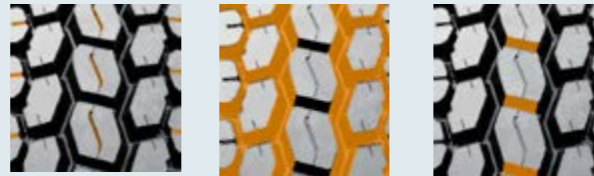

Features & Benefits:

- Tread block sipe design improves grip.
- Open shoulder and tread groove design reduce stone retention and improve traction.
- High strength casing for improved durability.

Size	L.I. / S.R.	P.R.	T.D.	RIM	O.D.	S.W.	S.L.R.	L.C.C.		
								mm	inch	mm
10R22.5	144/142M	14	18.5	7.50	1019	254	18.7	2575	2430	790
255/70R22.5	140/137L	16	20.0	7.50	936	255	17.1	2500	2300	830
295/75R22.5	144/141L	14	20.0	9.00	1020	298	18.7	2800	2575	760
	146/143L	16	20.0	9.00	1020	298	18.7	3000	2725	830
295/80R22.5	152/149K	18	18.5	9.00	1052	302	19.2	3550	3250	900
285/75R24.5	144/141L	14	20.0	8.25	1056	283	19.4	2800	2575	760
	147/144L	16	20.0	8.25	1056	283	19.4	3075	2800	830
11R22.5	146/143M	16	20.0	8.25	1065	279	19.33	3000	2725	830
11R22.5	144/142M	14	20.0	8.25	1065	279	19.33	2800	2650	720
11R24.5	149/146M	16	20.0	8.25	1116	279	20.31	3250	3000	830
11R24.5	146/143M	14	20.0	8.25	1116	279	20.31	3000	2725	720



The S757 is a winter drive tire that improves handling on ice and snow.

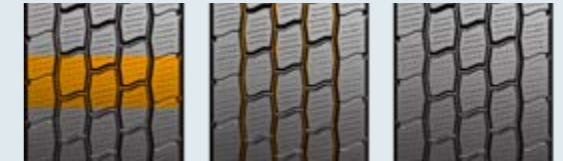

Features & Benefits:

- Widened running surface and four main grooves increase the tire's surface contact area from better grip.
- Unique groove, sipe, and open shoulder design strengthen handling and traction on ice and snow.

Size	L.I. / S.R.	P.R.	T.D.	RIM	O.D.	S.W.	S.L.R.	L.C.C.		
								mm	inch	mm
295/75R22.5	146/143L	16	21	9.00	1014	298	18.66	3000	2725	830
11R22.5	144/142L	14	21.0	8.25	1065	279	19.3	2800	2650	720
	146/143L	16	21.0	8.25	1065	279	19.3	3000	2725	830
11R24.5	149/146L	16	21.0	8.25	1116	279	20.3	3250	3000	830
	146/143L	14	21.0	8.25	1116	279	20.3	3000	2725	720



The S758 is designed for severe off-road applications. With an extra deep (32/32") tread depth and scrub resistant tread rubber, it is prepared for the most demanding environments. The ribbed design on the inside of the groove reduce stone retention while the open shoulder with tapered sidewalls improves stability. It is ideal for construction, logging, and other off-road environments.



Features & Benefits:

- Open grooves maximizes self-cleaning capabilities.
- Rib design inside the groove reduce stone retention.
- Extra deep tread (32/32") and M&S lug pattern are designed specifically for on and off-road applications.

Size	L.I. / S.R.	P.R.	T.D.	RIM	O.D.	S.W.	S.L.R.	L.C.C.		
								Single	Dual	A.P.
			mm	inch	mm	mm	inch	kg	kg	kPa
11R22.5	146/143G	16	25.5	8.25	1065	279	19.3	3000	2725	830
	146/143K	16	25	8.25	1065	279	19.33	3000	2725	830
11R24.5	149/146G	16	25.5	8.25	1116	279	20.3	3250	3000	830
	149/146K	16	25	8.25	1104	279	20.31	3250	3000	830



The S767's high scrub resistant and cool running tread design ensure an improved tread life and grip. The solid tire structure is reliable and offers great overall performance.



Features & Benefits:

- Wide grooves improve self-cleaning capabilities.
- Double S shaped tread blocks improve grip and traction.
- Widened tread surface for safe handling.
- Rib design connection blocks improves uniform wear.

Size	L.I. / S.R.	P.R.	T.D.	RIM	O.D.	S.W.	S.L.R.	L.C.C.		
								Single	Dual	A.P.
			mm	inch	mm	mm	inch	kg	kg	kPa
11R22.5	146/143L	16	19.5	8.25	1065	279	19.3	3000	2725	830
	148/145L	16	19.5	8.25	1065	279	19.3	3150	2900	850

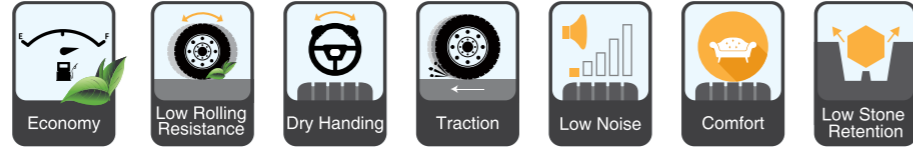

The S768 EFT is a premium closed shoulder drive tire designed with a wide shoulder featuring tapered lateral edges for improved stability. Stone ejectors at the bottom of the grooves reduce stone retention, while the extra-deep (26/32") tread depth improves tread life.

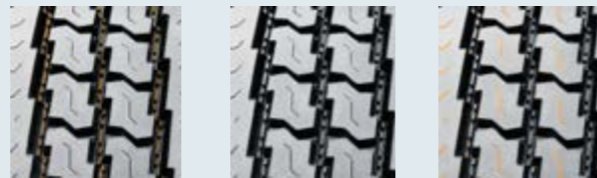

Features & Benefits:

- SmartWay® Verified-approved for use on EPA SmartWay® certified equipment.
- Stone ejectors reduce stone retention.
- Extra-deep tread pattern (26/32") with a special tread compound for a longer tread life.
- Wide footprint and square shoulder design improve stability and mileage.
- Sipe design improves traction in wet conditions and allow the tire to run cool for a longer tread life.

Size	L.I. / S.R.	P.R.	T.D.	RIM	O.D.	S.W.	S.L.R.	L.C.C.		
								mm	inch	mm
295/75R22.5	144/141L	14	20.0	9.00	1020	298	18.7	2800	2575	760
	146/143L	16	20.0	9.00	1020	298	18.7	3000	2725	830
285/75R24.5	144/141L	14	20.0	8.25	1056	283	19.4	2800	2575	760
	147/144L	16	20.0	8.25	1056	283	19.4	3075	2800	830
11R24.5	149/146M	16	20.0	8.25	1116	279	20.31	3250	3000	830
11R24.5	146/143M	14	20.0	8.25	1116	279	20.31	3000	2725	720
11R22.5	144/142M	14	20.0	8.25	1065	279	19.33	2800	2650	720

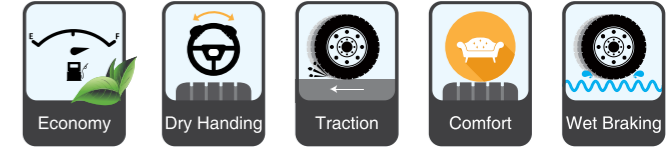

The new S792 comes equipped with a patented block and sipe pattern, new casing profile, and tread compound for outstanding wet and dry performance. Provides improved traction, cool running, and superior scrub resistance.



Features & Benefits:

- Altered footprint design.
- Minimum footprint shape help reduce irregular wear.
- Groove fence pattern reduces noise emissions for a more comfortable drive.

Size	L.I. / S.R.	P.R.	T.D.	RIM	O.D.	S.W.	S.L.R.	L.C.C.		
								mm	inch	mm
315/80R22.5	154/151L	18	18.0	9.00	1076	312	19.69	3750	3450	830
315/80R22.5	156/153L	20	18.0	9.00	1076	312	19.69	4000	3650	850



The S811 has reduced noise emissions with its varied pitch design and the closed shoulder offers good stability and improves uniform shoulder wear.



Features & Benefits:

- The large and deep shoulder grooves increase traction.
- The unique main groove design provides greater grip and traction, as well as improve stability and reduce irregular wear.
- The wider running surface and high strength tread formula improve puncture and scrub resistance.

Size	L.I. / S.R.	P.R.	T.D.	RIM	O.D.	S.W.	S.L.R.	L.C.C.		
								mm	inch	mm
7.50R20	135/133K	16	13.5	6.0	935	215	17.1	2180	2060	900
8.25R20	139/137K	16	13.0	6.5	974	236	17.8	2430	2300	930
9.00R20	144/142K	16	15.0	7.0	1019	259	18.5	2800	2650	900
10.00R20	149/146K	18	16.0	7.5	1054	278	19.1	3250	3000	930
	146/143K	16	16.0	7.5	1054	278	19.1	3000	2725	830
11.00R20	150/147K	16	16.5	8.0	1085	293	19.7	3350	3075	830
	152/149K	18	16.5	8.0	1085	293	19.7	3550	3250	930
12.00R20	154/149K	18	17.0	8.5	1125	315	20.3	3790	3270	840
	156/153K	20	17.0	8.5	1125	315	20.3	4000	3650	900
315/80R22.5	156/153K	20	16.0	9.00	1076	312	19.8	4000	3650	850
11R22.5	148/145M	16	16	8.25	1065	279	18.19	3150	2900	840
11R22.5	144/142M	14	16	8.25	1065	279	18.19	2800	2650	720
11R24.5	149/146M	16	16	8.25	1104	279	18.19	3250	3000	830
11R24.5	146/143L	14	16	8.25	1104	279	18.19	3000	2725	720



The S812 has reduced noise emissions with its varied pitch design and the closed shoulder offers good stability and improves uniform shoulder wear.



Features & Benefits:

- The unique groove angles and interior design improve grip and traction.
- The widened running surface and high strength tread formula offers excellent puncture and scrub resistance.

Size	L.I. / S.R.	P.R.	T.D.	RIM	O.D.	S.W.	S.L.R.	L.C.C.		
								mm	inch	mm
7.00R16LT	118/114K	14	11.5	5.50F	775	200	14.3	1320	1180	770
7.50R16LT	122/118K	14	12.5	6.00G	805	215	14.8	1500	1320	770
8.25R16LT	128/124K	16	13.5	6.50H	855	235	15.6	1800	1600	770



The S815 is a mixed service tread tire featuring a chip-resistant compound ideally suited for off-road and construction applications. A zigzag main groove pattern reduces stone retention, while maximizing traction under all applications. Sidewall protectors are engineered to provide an enhanced casing protection.



Features & Benefits:

- Large deep shoulder groove improve traction and help the tire run cool.
- Interlocking lugs promote improve stability and uniform wear.
- Wide footprint and unique shoulder design improve stability.
- Specially formulated compound and deep tread depth improve tread life.

Size	L.I. / S.R.	P.R.	T.D.	RIM	O.D.	S.W.	S.L.R.	L.C.C.		
								Single	Dual	A.P.
								mm	inch	mm
11R22.5	146/143K	16	18.0	8.25	1054	279	19.3	3000	2725	830
	148/145L	16	18.0	8.25	1054	279	19.3	3150	2900	850
12R22.5	152/149L	18	17.0	9.00	1085	300	19.8	3550	3250	930
13R22.5	154/151K	18	18.0	9.75	1124	320	20.5	3750	3450	875
	156/150L	18	18.0	9.75	1124	320	20.5	4000	3350	875
11R24.5	149/146K	16	18.0	8.25	1104	279	20.3	3250	3000	830
11.00R20	152/149K	18	16.5	8.0	1085	293	19.7	3550	3250	930
12.00R24	160/157K	20	16.0	8.5	1226	315	22.5	4500	4125	900
275/70R22.5	148/145K	16	17.5	8.25	958	276	17.6	3150	2900	900
295/80R22.5	152/148M	16	17.5	9.00	1044	298	19.2	3550	3150	850
315/80R22.5	161/157G	20	17.5	9.00	1076	312	19.7	4625	4125	900
315/80R22.5	161/157G	22	17	9.00	1076	312	19.69	4625	4125	900



The S816 has reduced noise emissions thanks to the the varied pitch tread pattern, while the high strength casing and reinforced bead improve service life. A closed shoulder design guarantees good stability and promotes uniform shoulder wear.



Features & Benefits:

- Sipes provide the tire with a strong grip and improved skid resistance.
- Super wide running surface, shoulder design, and special tread compound improve scrub resistance.
- The inclined zigzag grooves and rubber stone ejector at the bottom effectively reduce stone retention.

Size	L.I. / S.R.	P.R.	T.D.	RIM	O.D.	S.W.	S.L.R.	L.C.C.		
								Single	Dual	A.P.
								mm	inch	mm
10.00R20	146/142K	16	16.0	7.5	1054	278	19.1	3000	2630	840
	149/146K	18	16.0	7.5	1054	278	19.1	3250	3000	930
11.00R20	152/149K	18	16.0	8.0	1085	293	19.7	3550	3250	930
12.00R20	154/151K	18	17.0	8.5	1125	315	20.3	3750	3450	830
	154/149K	18	17.0	8.5	1125	315	20.3	3790	3270	840
	156/153K	20	17.0	8.5	1125	315	20.3	4000	3650	900

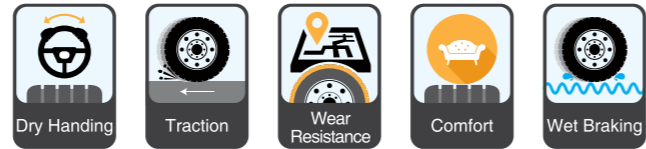

The S825 is an all-position mixed service tire engineered with a special rubber compound which improves scrub resistance. The stone ejectors within the groove reduce stone retention while the the angled tread blocks deliver excellent wet traction.



Features & Benefits:

- Interlocking lugs improve stability and uniform wear.
- Stone ejectors reduce stone retention.
- Wide footprint and unique shoulder design improve stability.
- Special tread compound improves tread life.

Size	L.I. / S.R.	P.R.	T.D.	RIM	O.D.	S.W.	S.L.R.	L.C.C.		
								Single	Dual	A.P.
			mm	inch	mm	mm	inch	kg	kg	kPa
385/65R22.5	160K(158L)	20	16.5	11.75	1072	389	19.4	4500	—	900
	160	20	16.5	11.75	1072	389	19.4	4500	—	900
	162K	22	16.5	11.75	1072	389	19.4	4750	—	930
	164K	24	16.5	11.75	1072	389	19.4	5000	—	930
425/65R22.5	165K	20	18.0	12.25	1124	422	20.3	5150	—	830
445/65R22.5	168K	20	17.0	13.00	1150	444	20.7	5600	—	830
	169K	20	17.0	13.00	1150	444	20.7	5800	—	900

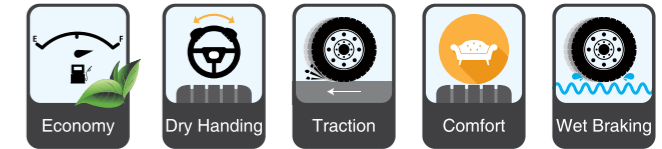

The S826 is an all position tire suitable for short-mid ranged range vehicles driving on mixed service roads. The strengthened bead construction enhances durability.

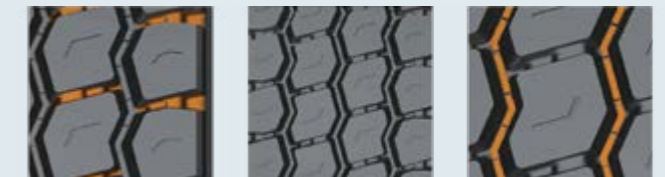

Features & Benefits:

- The open shoulder design allows the tire to run cool.
- The strengthened shoulder ribs and protrusions within the grooves improve scratch resistance and uniform wear.
- The unique groove design ensures driving stability and improves self-cleaning capabilities.
- The grip angle of the tire reduces rolling resistance for improved fuel economy.
- Unique tread formula effectively improves puncture resistance.
- The tread pattern grooves improve handling and grip.

Size	L.I. / S.R.	P.R.	T.D.	RIM	O.D.	S.W.	S.L.R.	L.C.C.		
								Single	Dual	A.P.
			mm	inch	mm	mm	inch	kg	kg	kPa
265/70R19.5	143/141J	18	16.0	7.5	867	262	15.8	2725	2575	900



The S827 is an all-position tire suitable for long-distance applications on highway and normal roads. Three main tread grooves and shallow sipes improve traction and grip. The closed shoulder design provides greater stability and reduces abnormal shoulder wear.

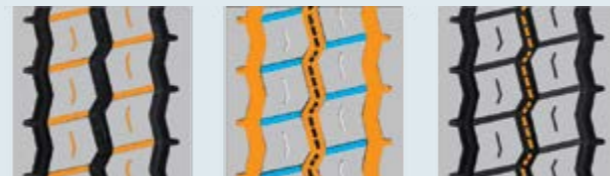

Features & Benefits:

- Fine pattern block sipes and small grooves provide excellent skid resistance.
- Three main grooves enhance traction and grip.
- Rubber ribs at the bottom of the groove reduce stone retention for improved self-cleaning capabilities.
- Optimized tread curve design lowers rolling resistance and improve fuel economy.

Size	L.I. / S.R.	P.R.	T.D.	RIM	O.D.	S.W.	S.L.R.	L.C.C.		
								mm	inch	mm
12.00R24	158/155K	18	16.0	8.5	1226	315	22.5	4250	3875	830
	160/157K	20	16.0	8.5	1226	315	19.9	4500	4125	900



The S828 is an all-position tire for long-distance transport vehicles driving on highway and normal roads. The tread pattern design improves traction and grip, and the high strength casing and tread improve driving safety.

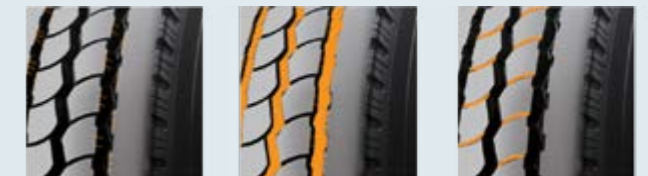

Features & Benefits:

- The groove designs allow the tire to run cool and improve uniform tread wear.
- The zigzag main grooves effectively increase traction and reduce stone retention.
- Small tread block grooves improve water drainage for better wet grip and performance.
- The tread contour design reduces low rolling resistance for improved fuel economy.

Size	L.I. / S.R.	P.R.	T.D.	RIM	O.D.	S.W.	S.L.R.	L.C.C.		
								mm	inch	mm
11R22.5	148/145K	16	16.0	8.25	1054	279	19.3	3150	2900	850
12R22.5	152/148K	16	16.5	9.00	1085	300	19.8	3550	3150	850
8.25R20	139/137K	16	13.5	6.5	974	236	17.8	2430	2300	930
9.00R20	144/142K	16	16.0	7.0	1019	259	18.5	2800	2650	900
10.00R20	146/143K	16	16.0	7.5	1054	278	19.1	3000	2725	830
	149/146K	18	16.0	7.5	1054	278	19.1	3250	3000	930
11.00R20	150/147K	16	16.0	8.0	1085	293	19.7	3350	3075	830
	152/149K	18	16.0	8.0	1085	293	19.7	3550	3250	930
12.00R20	154/151K	18	16.5	8.5	1125	315	20.3	3750	3450	830
7.50R16LT	122/118K	14	12.5	6.00G	805	215	14.8	1500	1320	770
8.25R16LT	128/124K	16	13.5	6.50H	855	235	15.6	1800	1600	770

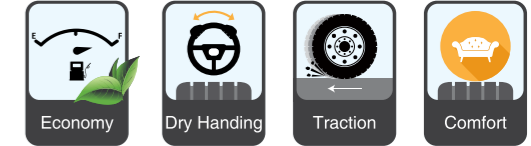
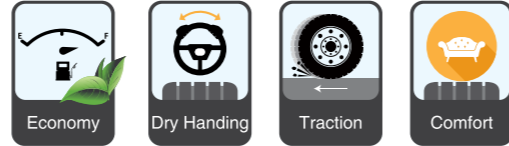

The new S860 boasts a longer tread life, improved uniform wear, and high strength tread.



Features & Benefits:

- New pattern design and tread formulation together work to create a strong tread and casing.
- Groove pattern provide strong grip in dry and wet weather to reduce the chances of hydroplaning.
- Strong shoulder design improves scrub resistance.
- Cool running.
- Uniform wear.

Size	L.I. / S.R.	P.R.	T.D.	RIM	O.D.	S.W.	S.L.R.	L.C.C.		
								mm	inch	mm
12.00R24	156/153K	18	13.5	8.5	1226	315	22.52	4000	3650	775
12.00R24	160/156K	20	13.5	8.5	1226	315	22.52	4500	4000	850



The new S861 is designed for short to mid ranged standard load trucks running on paved roads. The economic tread design improves uniform wear for a longer tread life.

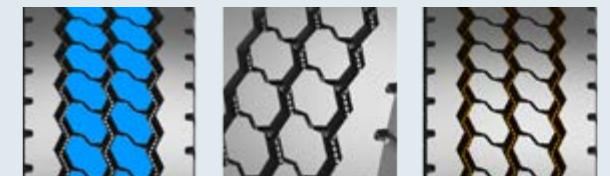

Features & Benefits:

- The main grooves with shallow sipes improve grip for great wet and dry performance.
- Improved shoulder design allows the tire to run cool for a longer tread life.
- The main tread grooves maximize traction performance under all applications.

Size	L.I. / S.R.	P.R.	T.D.	RIM	O.D.	S.W.	S.L.R.	L.C.C.		
								mm	inch	mm
325/95R24	162/160K	22	15.5	9.00	1228	312	22.6	4750	4500	850



The S880 pattern design improves handling and wet traction while the varied tread pitch lowers noise emissions. A wider running surface improves traction and handling.



Features & Benefits:

- The tread pattern main tread grooves, block grooves, and curved shaped improve wet grip and traction.
- Outer profile design helps improve uniform wear.
- The wider tread surface and special tread compound improves scrub resistance for a longer tread life.

Size	L.I. / S.R.	P.R.	T.D.	RIM	O.D.	S.W.	S.L.R.	L.C.C.		
								Single	Dual	A.P.
			mm	inch	mm	mm	inch	kg	kg	kPa
11R22.5	144/142L	14	17.0	8.25	1065	279	19.3	2800	2650	720
	146/143L	16	17.0	8.25	1065	279	19.3	3000	2725	830
	148/145L	16	17.0	8.25	1065	279	19.3	3150	2900	850
225/80R17.5	123/122L	14	13.0	6.75	805	226	14.7	1550	1500	700
245/70R19.5	136/134M	16	15.5	7.50	845	248	15.4	2240	2120	825
265/70R19.5	140/138J	16	15.5	7.50	873	262	15.8	2500	2360	775
275/70R22.5	148/145K	16	16.5	8.25	964	276	17.6	3150	2900	900
275/80R22.5	151/148J	18	18.0	8.25	1012	276	18.5	3450	3150	900



The new S889 is an all-position tire for long haul applications. Three main grooves with a zigzag tread design provide great stability and driving comfort. Block sipes improve tread softness for better wet traction.



Features & Benefits:

- Tread block sipes provide superior wet performance by improving traction and grip.
- Zigzag grooves reduce stone retention.
- Wide tread and special tread compound maintain uniform wear for a longer tread life.

Size	L.I. / S.R.	P.R.	T.D.	RIM	O.D.	S.W.	S.L.R.	L.C.C.		
								Single	Dual	A.P.
			mm	inch	mm	mm	inch	kg	kg	kPa
10.00R20	149/146K	18	16.0	7.5	1054	278	19.13	3250	3000	930
11.00R20	150/147K	16	16.5	8.0	1085	293	19.65	3350	3075	830
	152/149K	18	16.5	8.0	1085	293	19.65	3550	3250	930
12.00R20	154/151K	18	16.5	8.5	1125	315	20.31	3750	3450	830
	158/155J	22	16.5	8.5	1125	315	20.31	4250	3875	970
11R22.5	148/145L	16	16.0	8.25	1054	279	19.33	3150	2900	850
12R22.5	152/149K	18	16.5	9.00	1085	300	19.84	3550	3250	930

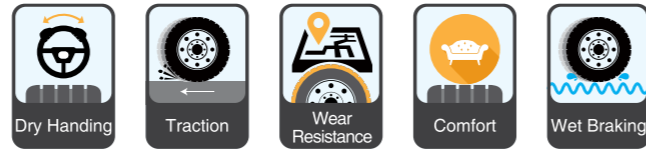

The S909's unique tread design and compound formulation ensures uniform wear for a longer tread life and reduces stone retention. The open shoulder design allows the tire to run cool.

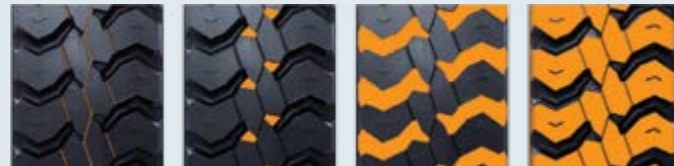

Features & Benefits:

- Thin grooves improve grip on wet roads for improved driving safety.
- Unique pattern grooves reduce stone retention.
- Large pattern blocks and unique pattern grooves improve grip and traction.
- Center tread pattern design improves grip.

Size	L.I. / S.R.	P.R.	T.D.	RIM	O.D.	S.W.	S.L.R.	L.C.C.		
								Single	Dual	A.P.
								mm	inch	kPa
10.00R20	146/143J	16	16.0	7.5	1054	278	19.1	3000	2725	830
	149/146J	18	16.0	7.5	1054	278	19.1	3250	3000	930
11.00R20	150/147J	16	17.0	8.0	1085	293	19.7	3350	3075	830
	152/149J	18	17.0	8.0	1085	293	19.7	3550	3250	930



The S911's bead is designed to improve durability while the special tread design reduces stone retention while improving traction.



Features & Benefits:

- The small grooves between the blocks allow the tire to run cool and improve uniform tread wear.
- Deepened grooves offer a longer tread life.
- Overall tread pattern design is specially designed to improve block rigidity in the center and provide better balance on the shoulders to improve uniform wear.

Size	L.I. / S.R.	P.R.	T.D.	RIM	O.D.	S.W.	S.L.R.	L.C.C.		
								Single	Dual	A.P.
								mm	inch	kPa
13R22.5	154/151G	18	21.0	9.75	1136	320	20.5	3750	3450	830
	156/150K	18	21.0	9.75	1136	320	20.5	4000	3350	875
8.25R20	139/137G	16	16.0	6.5	986	236	17.8	2430	2300	930
9.00R20	144/142F	16	17.0	7.0	1030	259	18.5	2800	2650	900
10.00R20	146/143G	16	17.5	7.5	1065	278	19.1	3000	2725	830
	149/146G	18	17.5	7.5	1065	278	19.1	3250	3000	930
11.00R20	150/147F	16	20.5	8.0	1096	293	19.7	3350	3075	830
	152/149E	18	20.5	8.0	1096	293	19.7	3550	3250	930
12.00R20	154/151F	18	18.5	8.5	1136	315	20.3	3750	3450	830
	156/153F	20	18.5	8.5	1136	315	20.3	4000	3650	900
	158/155F	22	18.5	8.5	1136	315	20.31	4250	3875	970
11R22.5	146/143L	16	19.5	8.25	1065	279	19.33	3000	2725	830
	148/145L	16	19.5	8.25	1065	279	19.33	3150	2900	850



The S913 is a drive position tire suitable for all type of trucks.



Features & Benefits:

- Aggressive, deep tread pattern made with a durable tread compound.
- Angled grooves reduce stone retention.
- Strong casing and strengthened tread blocks improves traction, while also improving wear, cut, and chip resistance.
- Long tread life.

Size	L.I. / S.R.	P.R.	T.D.	RIM	O.D.	S.W.	S.L.R.	L.C.C.		
								Single	Dual	A.P.
								mm	kg	kPa
12.00R24	156/153K	18	19.0	8.5	1226	315	22.52	4000	3650	775
12.00R24	160/156K	20	19.0	8.5	1226	315	22.52	4500	4000	850
315/80R22.5	154/151K	18	19.0	9.00	1076	312	19.69	3750	3450	830
315/80R22.5	156/153K	20	19.0	9.00	1076	312	19.69	4000	3650	850
12R22.5	150/147K	16	20.5	9.00	1085	300	19.84	3350	3075	830
12R22.5	152/149K	18	20.5	9.00	1085	300	19.84	3550	3250	930



The S917 is a drive tire engineered to work in demanding applications such as mining, construction, and logging. The tread design is an aggressive multi-lug design which provides exceptional off-road traction while the enhanced rubber compound improves cut and chunking resistance. Open shoulder design delivers superior stability and uniform wear. The deep 31/32" tread depth offers a longer tread life and exceptional fuel efficiency.



Features & Benefits:

- Aggressive multi-lug design.
- Deeper tread for a longer tread life.

Size	L.I. / S.R.	P.R.	T.D.	RIM	O.D.	S.W.	S.L.R.	L.C.C.		
								Single	Dual	A.P.
								mm	kg	kPa
11R22.5	148/145G	16	24.0	8.25	1065	279	19.3	3150	2900	850
12R22.5	152/149G	18	23.5	9.00	1096	300	19.8	3550	3250	930
13R22.5	156/150G	18	24.5	9.75	1136	320	22.5	4000	3350	875
11R24.5	149/146G	16	24.0	8.25	1116	279	20.3	3250	3000	830
10.00R20	146/143F	16	23.5	7.5	1065	278	19.1	3000	2725	830
	149/146F	18	23.5	7.5	1065	278	19.1	3250	3000	930
11.00R20	152/149F	18	23.5	8.0	1096	293	19.7	3550	3250	930
12.00R20	154/151F	18	23.5	8.5	1136	315	20.3	3750	3450	830
12.00R24	160/157F	20	32.0	8.5	1238	315	22.5	4500	4125	900
7.50R16LT	122/118G	14	14.0	6.00G	815	215	14.8	1500	1320	770
8.25R16LT	128/124G	15	15.0	6.50H	865	235	15.6	1800	1600	770
295/80R22.5	152/148J	16	24.5	9.00	1054	298	19.2	3550	3150	850
315/80R22.5	156/150G	18	24.5	9.00	1076	312	19.7	4000	3350	850
235/75R17.5	143/141G	16	17	6.75	797	233	14.69	2725	2575	860
315/80R22.5	157/154G	20	24	9.00	1076	312	19.69	4125	3750	900
265/70R19.5	143/141G	18	17.5	7.50	867	262	15.8	2725	2575	900
315/80R22.5	156/150G	18	23.5	9.00	1082	312	19.69	4000	3350	850
	(154/150J)									
315/80R22.5	157/154G	20	24	9.00	1076	312	19.69	4125	3750	900

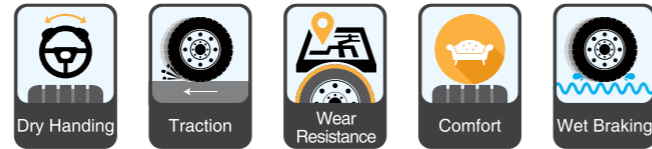

The S918 is specially designed for short to mid transportation on non-paved roads. The bead structure improves tire durability while the tread compound improves puncture and tear resistance. The large lug design improves traction.

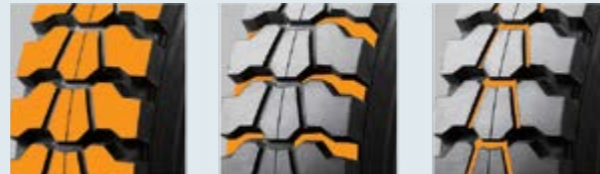

Features & Benefits:

- Large pattern blocks and deepened grooves improve tire traction and grip.
- Open shoulder design and wide/deepened horizontal grooves reduce stone retention, and strong traction on non-paved roads.
- Connecting ribs between pattern blocks are designed to increase their rigidity for improve tear resistance.

Size	L.I. / S.R.	P.R.	T.D.	RIM	O.D.	S.W.	S.L.R.	L.C.C.		
								Single	Dual	A.P.
			mm	inch	mm	mm	inch	kg	kg	kPa
7.00R16LT	118/114G	14	13.0	5.50F	775	200	14.3	1320	1180	770
8.25R20	139/137G	16	16.5	6.5	986	236	17.8	2430	2300	930
9.00R20	144/142F	16	20.5	7.0	1030	259	18.6	2800	2650	900



The S929 employs a directional pattern design for improved wear resistance and self-cleaning capabilities. The bead structure is designed to improve durability and the large lug pattern offers greater traction.

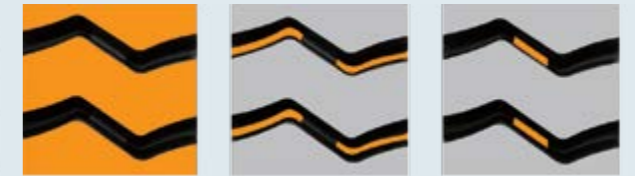

Features & Benefits:

- The large horizontal lug design offers excellent traction.
- Deepened groove depth improves tread life.
- Ribs inside the grooves improve strength for better force transition and tear resistance while the pattern lugs improve grip.

Size	L.I. / S.R.	P.R.	T.D.	RIM	O.D.	S.W.	S.L.R.	L.C.C.		
								Single	Dual	A.P.
			mm	inch	mm	mm	inch	kg	kg	kPa
10.00R20	146/143F	16	23.5	7.5	1065	278	19.1	3000	2725	830
	149/146F	18	23.5	7.5	1065	278	19.1	3250	3000	930
11.00R20	152/149F	18	23.5	8.0	1096	293	19.7	3550	3250	930
12.00R20	154/151F	18	23.5	8.5	1136	315	20.3	3750	3450	830
	156/153F	20	23.5	8.5	1136	315	20.31	4000	3650	900

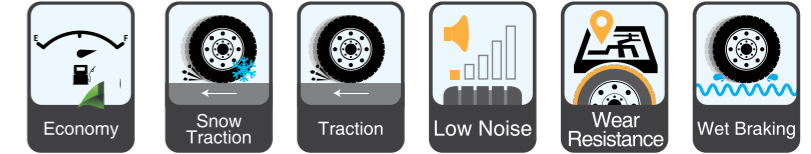
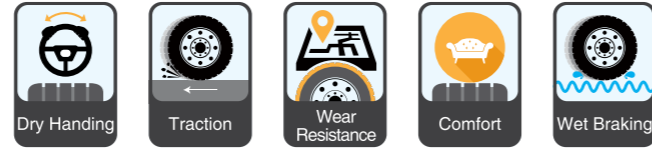

The S951 tire employs large blocks with deep grooves which have strong resistance to puncturing, chunking, and provide excellent traction. The groove design effectively reduces stone retention to improve casing protection and tread life. The tire is especially useful on poor road conditions.

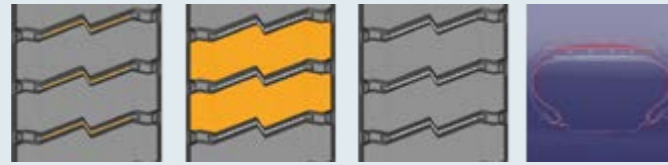

Features & Benefits:

- The bottom of the groove is reinforced with small ribs to reduce stone retention and protect the tire casing.
- Tread compound formulation improve puncture, cut, and scratch resistance.

Size	L.I. / S.R.	P.R.	T.D.	RIM	O.D.	S.W.	S.L.R.	L.C.C.		
								mm	inch	mm
315/80R22.5	156/150K	18	23.0	9.00	1076	312	19.7	4000	3350	850
315/80R22.5	156/150K (154/150L)	18	22	9.00	1082	312	19.69	4000	3350	850



The SW01 is designed specifically for winter weather driving. The wide running surface and deep tread design improve tread life. The sipes design increases tread contact area and block rigidity for better winter weather grip and traction.



Features & Benefits:

- Unique wave-like sipe design increases contact area and improves rigidity for better grip and traction.
- Open groove design improves grip and traction for a safer winter weather driving experience.
- Cold resistant compound and tread design improve winter weather driving capabilities.

Size	L.I. / S.R.	P.R.	T.D.	RIM	O.D.	S.W.	S.L.R.	L.C.C.		
								mm	inch	mm
11R22.5	144/142L	14	21.5	8.25	1065	279	19.3	2800	2650	720
	146/143L	16	21.5	8.25	1065	279	19.3	3000	2725	830
	148/145L	16	21.5	8.25	1065	279	19.3	3150	2900	850
	149/146L	16	21.5	8.25	1116	279	20.31	3250	3000	830
	146/143L	14	21.5	8.25	1116	279	20.31	3000	2725	720
295/75R22.5	146/143L	16	21.5	9.00	1014	298	18.66	3000	2725	830

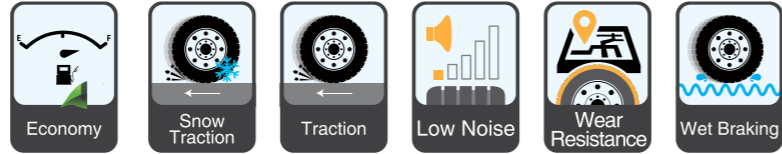

The SW02 is designed with a cold resistant tread compound and the tread pattern design employs multiple grooves and sipes for greater driving capabilities on snow and ice. A slip-resistant tread formula is made specifically for winter weather conditions and the multi-block groove design in the tread safely and effectively discharge snow. Zigzag sipes improve the tread contact area for greater block rigidity and improved grip on snow and ice.



Features & Benefits:

- Zigzag sipes design improves winter weather grip.
- Cold-resistant tread compound and tread pattern grooves improve snow and ice traction.
- Special tread compound formulation improves winter weather safety.

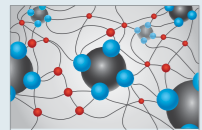

Cold rubber tread maintains flexibility and normal capabilities in low temperatures.



3D kerfs make the tread blocks contact the road surface more stable and keep more contact area when the force is applied.

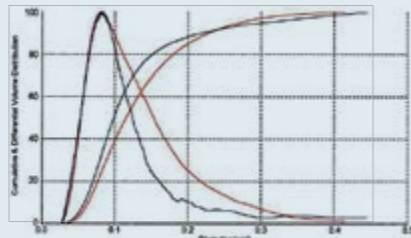

Tread compound reinforced with lower heat build-up carbon black improves mileage, durability and rolling resistance, maintaining grip characteristic.

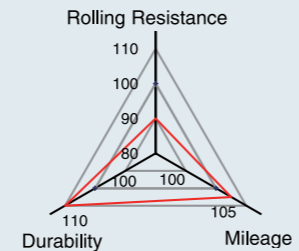

Size	L.I. / S.R.	P.R.	L.C.C.							
			T.D.	RIM	O.D.	S.W.	S.L.R.	Single	Dual	A.P.
			mm	inch	mm	mm	inch	kg	kg	kPa
295/80R22.5	150/147M	16	21.0	9.00	1044	298	19.2	3350	3075	830
	152/148L	16	21.0	9.00	1044	298	19.2	3550	3150	850
	152/149L	18	21.0	9.00	1044	298	19.2	3550	3250	900
315/70R22.5	152/148	16	21.0	9.00	1014	280	18.5	3550	3150	850
	154/150(152/148)	18	21.0	9.00	1014	280	18.5	3750	3350	900
315/80R22.5	156/150(154/150)	18	21.0	9.00	1076	270	19.7	4000	3350	850

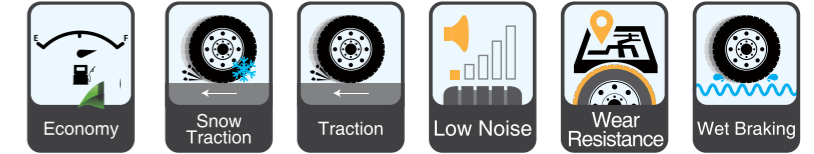

The SW03 employs a cold resistant tread compound formula and multi-block/groove design for improved winter weather performance. The sipes design increases tread contact area and block rigidity for better winter weather grip and traction.



Features & Benefits:

- Unique sipe design allows the tire to run cool and improve grip.
- Increased number of tread grooves effectively drain snow for improved driving safety on ice and snow.
- Cold resistant tread compound, fine sipes, and dense grooves improve safety in winter weather conditions.

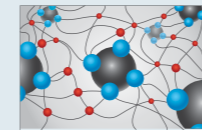

Cold rubber tread maintains flexibility and normal capabilities in low temperatures.

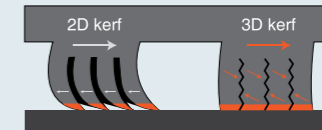

3D kerfs make the tread blocks contact the road surface more stable and keep more contact area when the force is applied.

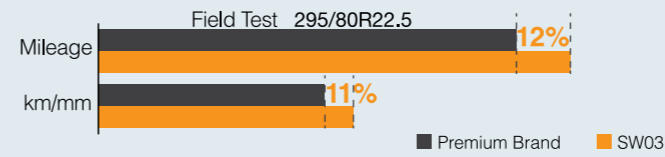

Size	L.I. / S.R.	P.R.	T.D.	RIM	O.D.	S.W.	S.L.R.	L.C.C.		
								Single	Dual	A.P.
								kg	kg	kPa
295/80R22.5	150/147M	16	21.0	9.00	1044	298	19.2	3350	3075	830
	152/148L	16	21.0	9.00	1044	298	19.2	3550	3150	850
	152/149L	18	21.0	9.00	1044	298	19.2	3550	3250	900

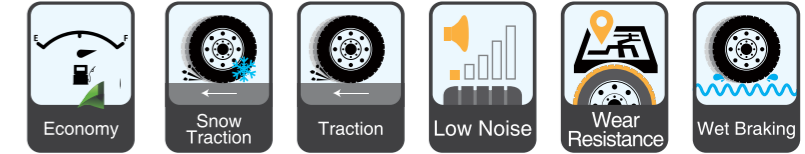
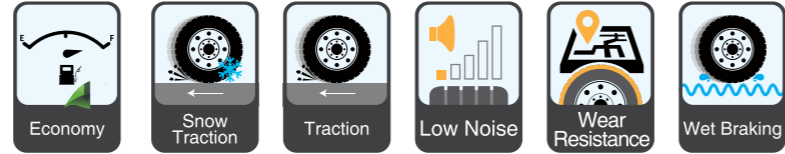

The SW05 is equipped for all winter weather conditions thanks to the special slip and cold-resistant tread formula and tread pattern which effectively improve grip and traction on snow and ice. Unique groove design increases the ground contact area for improved traction and split resistance on ice.



Features & Benefits:

- Unique groove design effectively drains snow for improve grip and slip-resistance on ice and snow.
- Tread grooves and sipes improve driving safety on ice and snow.

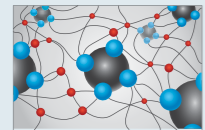

Cold rubber tread maintains flexibility and normal capabilities in low temperatures.



3D kerfs make the tread blocks contact the road surface more stable and keep more contact area when the force is applied.

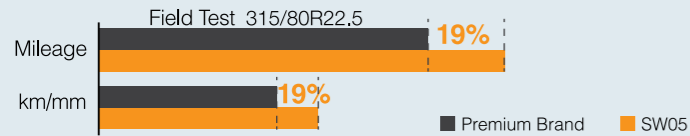

Size	L.I. / S.R.	P.R.	T.D.	RIM	O.D.	S.W.	S.L.R.	L.C.C.		
								mm	inch	mm
225/80R17.5	123/122L	14	13.0	6.75	805	226	14.7	1550	1500	700
245/70R19.5	136/134J	16	19.0	7.5	839	248	15.4	2240	2120	850
265/70R19.5	140/138L	16	20.0	7.50	873	262	15.8	2500	2360	775
265/70R19.5	143/141J	18	20.0	7.50	873	262	15.8	2725	2575	900
315/80R22.5	156/150(154/150)L(M)	18	22.0	9.00	1076	312	19.7	4000	3350	850
	148/145L	16	20.0	8.25	1065	279	19.3	3150	2900	850
11R22.5	144/142L	14	20.0	8.25	1065	279	19.3	2800	2650	720
	146/143L	16	20.0	8.25	1065	279	19.3	3000	2725	830



The new SW06 is an all-position specialty winter tire that improves handling on ice and snow. The wide tread width and five main grooves increase the tire's contact area and improves grip. M+S and 3PMSF identification represent the tire's excellent winter performance. Unique sipe pattern and open shoulder design effectively drain water.

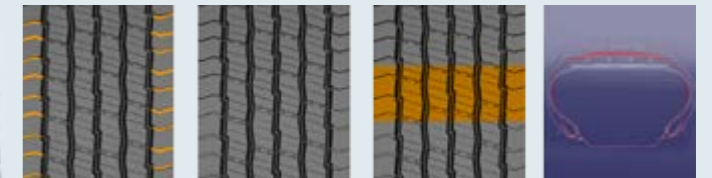

Features & Benefits:

- Unique serrated sipe design improves tire ground contact area, pattern rigidity, and offers better grip.
- Open lateral grooves provide excellent driving performance.
- Widened tread and five main grooves improve ground contact area and grip.

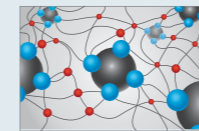

Cold rubber tread maintains flexibility and normal capabilities in low temperatures.

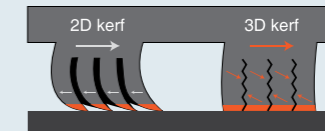

3D kerfs make the tread blocks contact the road surface more stable and keep more contact area when the force is applied.

Dual Tread Radius Design

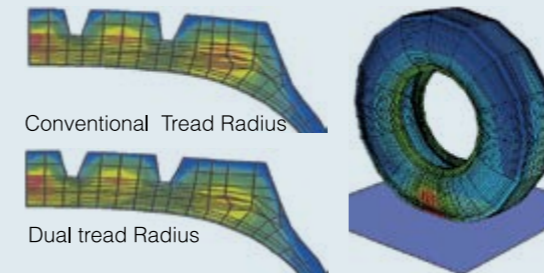

The computer simulated Tread radius ensures uniform road contacts for tyre performance, even wear and tread durability.

Dual Tread Radius design reduces heat generation in shoulder blocks that brings better mileage, tread durability and low rolling resistance.

Size	L.I. / S.R.	P.R.	T.D.	RIM	O.D.	S.W.	S.L.R.	L.C.C.		
								mm	inch	mm
385/55R22.5	160(158)K(L)	20	15.0	12.25	996	386	18.3	4500	--	900
385/65R22.5	160(158)K(L)	20	15.0	11.75	1072	389	19.4	4500	--	900
315/70R22.5	154/150(152/148)L(M)	18	17.0	9.00	1014	312	18.5	3750	3350	900
295/80R22.5	152/148M	16	17.0	9.00	1044	298	19	3550	3150	850
315/80R22.5	156/150(154/150)L(M)	18	17.0	9.00	1076	312	19.7	4000	3350	850

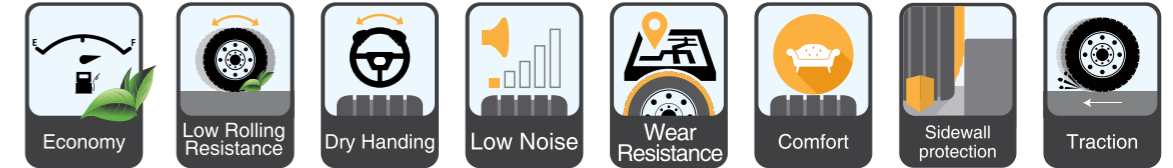

Scuff damage Resistant Sidewall

The sidewall protector is designed to counter frequent damages from kerbs and other road hazards caused by the endless stops and starts for public transportation so to improve service life.

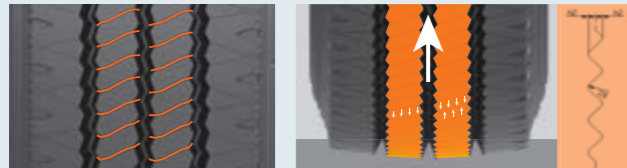

Patented Sipe Technology

Sipe design effectively increases contact area between the tread and road surface, which enhances grip and reduces skidding for greater driving safety.

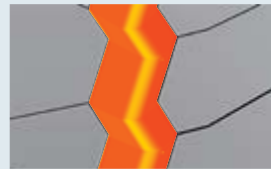

Special Shoulder Notch Design

Shoulder notch design allows the tire to run cool for better durability.

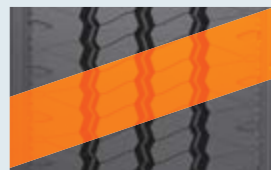

Multi-Pitch Pattern Design

Optimized tread pattern design to reduce tyre noise and improve ride comfort. Design for longer Tread Life. City Convoy introduces durable rubber material to its tread formula. The ultra-wear-resistant carbon black to improve wear index. Extra deep tread for long mileage.

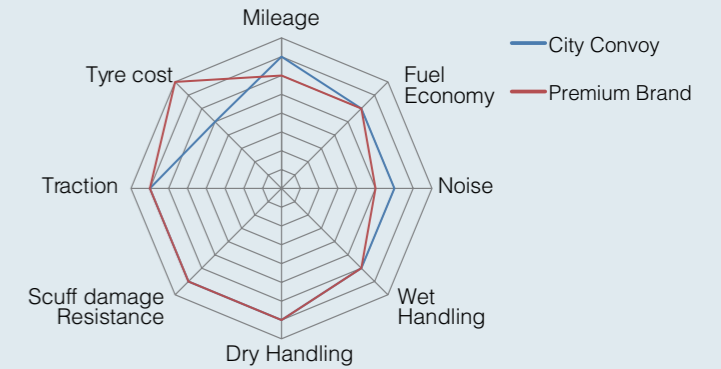

Cost Per 1000 Km

- High saving potential thanks to low costs per mileage

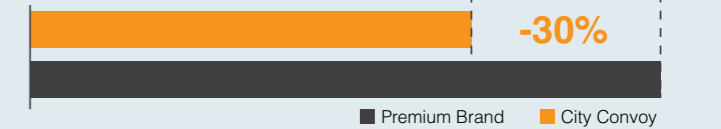

Original profile

- 1 Bottom of tread groove
- 2 Tread wear indicator
- 3 Regroove depth indicator
- 4 Layer of under tread rubber

Profile before regrooved

- 5 After regrooved
- Thickness of rubber to be regrooved
- Thickness of rubber to be retained 2mm

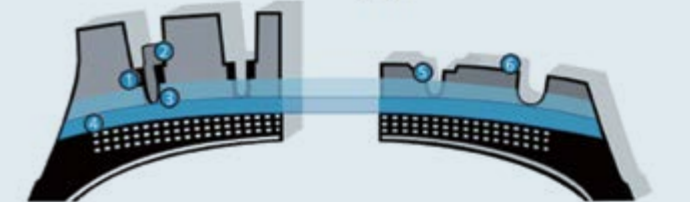

- P Depth remaining before regroove
- H Theoretical height of regrooving
- L Blade setting: $L = P + H$
We recommend that you measure L with a depth gauge
- e Thickness of rubber to be kept after regrooving: 2mm
- 1 Height of the wear indicator
- 2 Recess indicating the regrooving depth

Size	L.I. / S.R.	P.R.	T.D. mm	RIM inch	O.D. mm	S.W. mm	S.L.R. inch	L.C.C.		
								Single kg	Dual kg	A.P. kPa
275/70R22.5	148/145(152/148)J(E)	16	21.0	8.25	958	276	17.6	3150	2900	900
295/80R22.5	152/149K	18	17.5	9.00	1044	298	19.17	3550	3250	900
305/70R22.5	153/150J	20	17.5	9.00	1000	305	18.19	3650	3350	900
11R22.5	148/145J	16	20	8.25	1065	279	19.33	3150	2900	850



Developed as an all-position tire for highway long-haul busses in all markets.

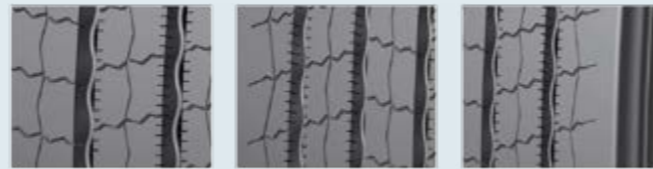

Features & Benefits:

- All-position tire for long-haul busses running on highways
- Groove pattern employs an S shaped design to improve self-cleaning capabilities and reduce damage from stones.
- Zig-zag sipes improve grip and traction to reduce partial grinding.
- Four variable pitch designs reduce tire noise.
- Widened shoulder block design optimize even wear.

Size	L.I. / S.R.	P.R.	T.D. mm	RIM inch	O.D. mm	S.W. mm	S.L.R. inch	L.C.C.		
								Single kg	Dual kg	A.P. kPa
295/80R22.5	154/149M	18	15	9.00	1044	298	19.17	3750	3250	850
295/80R22.5	152/148M	16	15	9.00	1044	298	19.17	3750	3150	850



REV 1.18